

INNOVATIONS 2020 | 01

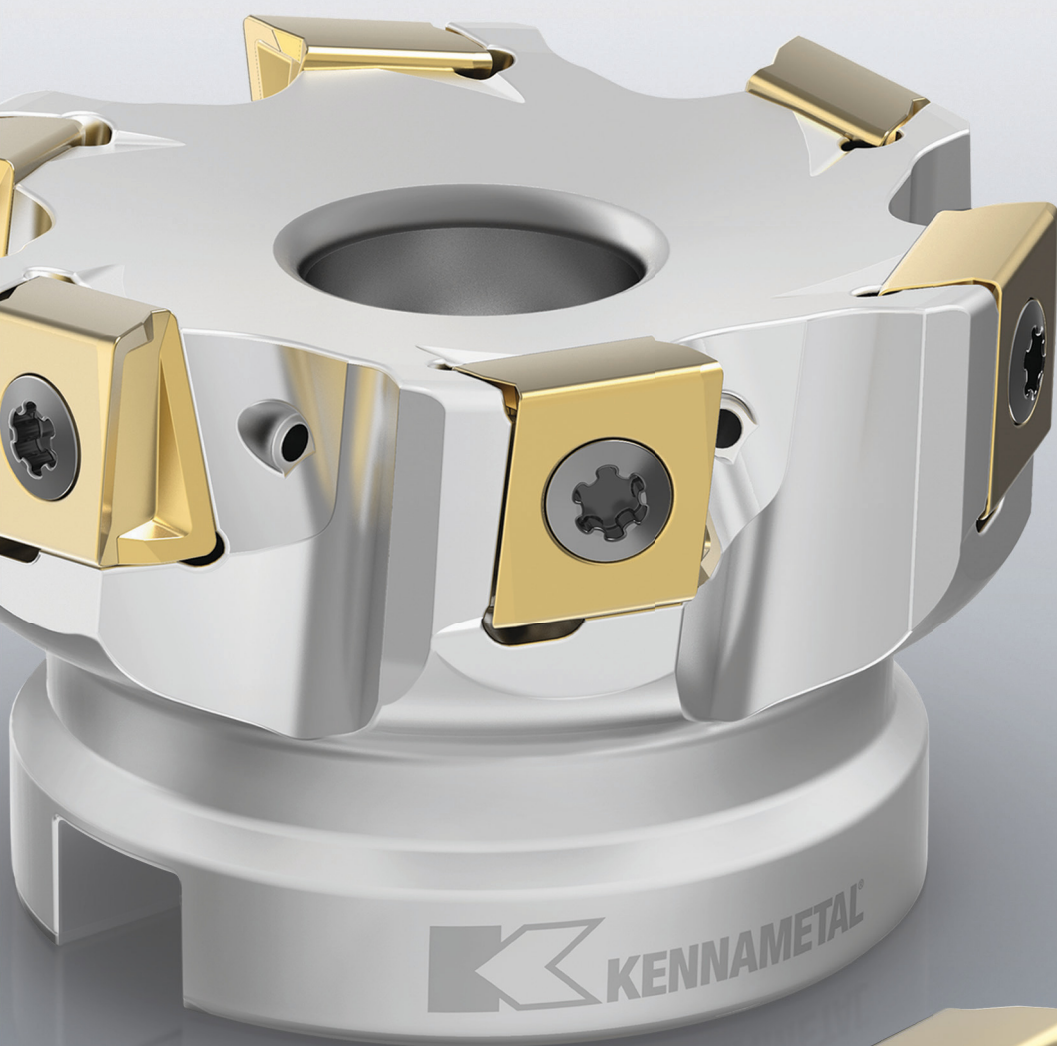

METRIC

Turret Adapted Clamping Units

Turret adapted clamping units provide unmatched performance and guaranteed productivity improvement.



INNOVATIONS

Services & Support	2-5
Contact Information	2-3
Spare Parts & Accessories Information • Online Catalogue.....	4-5
Indexable Milling	6-16
Mill 4-12 ^{KT} • Tangential Shoulder Milling.....	6-16
Solid End Milling	18-25
HARVI II TCDE (5 x D)	18-25
Tooling Systems	26-72
TACU • Product Expansion	26-64
Technical Section.....	66-69
ER Solid Collets	70-72
General Information	74-77
Grade Descriptions	74-75
Key to Column Headings	76
Material Cross Reference.....	77

CAS — Customer Application Support

Get Fast and Reliable Answers to Your Toughest Problems

Our CAS Team is the metalworking industry's leading help desk resource for tooling application solutions and problem resolution.

Easy Access to Proven Metalworking Expertise!

Kennametal Application Engineers assist customers and engineering groups throughout the world with expert tool selection and application recommendations for the entire range of Kennametal tooling.



Region	Originating Country	Language	CAS Hotline	Email
North America	USA	English	800 835 3668	na.techsupport@kennametal.com
	Mexico	Spanish	1800 253 0758	na.techsupport@kennametal.com
Africa	South Africa	English	0800 981643	na.techsupport@kennametal.com
Europe	Austria	German	0800 202873	eu.techsupport@kennametal.com
	Belgium	English/French	0800 80850	eu.techsupport@kennametal.com
	Denmark	English	808 89298	na.techsupport@kennametal.com
	Finland	English	0800 919412	na.techsupport@kennametal.com
	France	French	080 5540 367	eu.techsupport@kennametal.com
	Germany	German	0800 0006651	eu.techsupport@kennametal.com
	Israel	English	1809 449889	na.techsupport@kennametal.com
	Italy	Italian	800 916561	eu.techsupport@kennametal.com
	Netherlands	English	0800 0201 130	eu.techsupport@kennametal.com
	Norway	English	800 10080	na.techsupport@kennametal.com
	Poland	Polish	0080 04411887	eu.techsupport@kennametal.com
	Russia (landline)	Russian	8800 5556394	eu.techsupport@kennametal.com
	Russia (cell phone)	Russian	+7 800 5556394	eu.techsupport@kennametal.com
Asia Pacific	Australia	English	1800 666 667	ap-kmt.techsupport@kennametal.com
	India	English	1 800 103 5227	in.techsupport@kennametal.com
	Japan	English	03 3820 2855	ap-kmt.techsupport@kennametal.com
	Korea (South)	English	+82 2 2100 6100	ap-kmt.techsupport@kennametal.com
	Malaysia	English	1800 812 990	ap-kmt.techsupport@kennametal.com
	New Zealand	English	0800 450 941	ap-kmt.techsupport@kennametal.com
	Singapore	English	1800 6221031	ap-kmt.techsupport@kennametal.com
Taiwan	English	0800 666 197	ap-kmt.techsupport@kennametal.com	
Thailand	English	1800 4417820	ap-kmt.techsupport@kennametal.com	

Numbers shown only serve the originating country listed.



Service & Sales Centres Around the World

Region	Country	Sales Hotline	Email
North America	United States	+1 800 446 7738	FtMill.Service@kennametal.com
	Canada	+1 800 446 7738	toronto.service@kennametal.com
	Mexico	+1 888 402 4963	k-mx.service@kennametal.com
Central/South America	Argentina	+54 11 4719 0700	buenos-aires.ventas@kennametal.com
	Brazil	+55 19 3936 9200	bra.marketing@kennametal.com
	Chile	+56 2 2264 1177	kennametalchile@kennametalchile.cl
Africa	Egypt	+44 1384 408060	na.techsupport@kennametal.com
	South Africa	+27 11 748 9300	na.techsupport@kennametal.com
Europe	Austria	+43 2236 3798980	brunn.sales@kennametal.com
	Belgium	+32 0800 81 372	belgium.sales@kennametal.com
	Czech Republic	+420 800 900 840	k-prha.sales@kennametal.com
	France	+33 1 60 12 81 00	info.fr@kennametal.com
	Germany	+49 6003 8277 0	rosbach.sales@kennametal.com
	Great Britain	+44 1384 408060	kingswinford.service@kennametal.com
	Hungary	+36 96 618 150	gyoer.sales@kennametal.com
	Ireland	+44 1384 408060	na.techsupport@kennametal.com
	Italy	+39 02 895 961	milano.vendite@kennametal.com
	Luxemborg	+32 4 248 48 48	liege.sales@kennametal.com
	Netherlands	+31 0800 44 33 201	netherlands.sales@kennametal.com
	Poland	+48 61 6656501	poland.service@kennametal.com
	Portugal	+351 22 4119 400	porto.service@kennametal.com
	Russia	+7 495 4115386	moscow.information@kennametal.com
Slovakia	+421 0800 044 053	k-eu-zilina.sales@kennametal.com	
Spain	+34 93 586 03 50	barcelona.service@kennametal.com	
Turkey	+90 216 574 4780	tr.information@kennametal.com	
Asia Pacific	Australia	+61 800 666 667	k-au.service@kennametal.com
	China	+86 400 889 2135	k-cn.service@kennametal.com
	India	+91 800 103 5138	k-bngl.information@kennametal.com
	Indonesia	+65 6265 9222	k-sg.sales@kennametal.com
	Japan	+81 3 3820 2855	k-jp.service@kennametal.com
	Korea (South)	+82 2 2109 6100	k-kr-service@kennametal.com
	Malaysia	+60 3 5569 9080	k-sg.sales@kennametal.com
	New Zealand	+64 0800 536626	k-nz.service@kennametal.com
	Singapore*	+65 62659222	k-sg.sales@kennametal.com
	Taiwan	+886 4 2350 1920	taiwan.service@kennametal.com
Thailand	+66 2 642 3455	k-sg.sales@kennametal.com	

*Vietnam and Philippines individuals should contact the Singapore office.

Visit kennametal.com to find local Authorised Kennametal Distributors.



Spare Parts & Accessories Information

Lost a screw? Have to replace worn-out clamping wedges?
Need to find and re-order those spare parts?

Are you in need of some accessories, like a torque wrench or coolant shower plate? These tools are at your fingertips!
Go to kenametal.com and find what you need in seconds. Enter the catalogue number of the corresponding tool, and it will display.

1 STEP 1 Enter the tool catalogue number here

KENNAMETAL

Search By Keyword, Part #, ANSI/ISO

PRODUCTS SOLUTIONS SERVICES RESOURCES SUPPORT ABOUT US

English / Products / Metalworking Tools / Milling / Indexable Milling / Milling Inch Tools / Face Mills / Mill 16 / Mill 16 • Shell Mills

Mill 16™

Shell Mills

Features and Benefits

- Productivity booster for machining cast iron materials.
- Insert with 16 cutting edges.

SPECIFICATIONS

Mill 16 • Shell Mills • Wedge Clamping

Show 10 entries

order number	catalog number	D1	D1 max	D	D6	L	Ap1 max	Z	lbs	max RPM
6001979	MILL16E200Z35ON08W	2.000	2.495	.750	2.000	2.000	.215	5	1.45	11100

2 STEP 2 Select the spare parts & accessories

PRODUCT USAGE /

Insert Selection Inserts Tool Body Speeds & Feeds Grades **Spare Parts**

Spare Parts

D1 wedge	wedge screw	in. lbs.	wrench	mounting screw with coolant grooves	adjustable torque wrench	bit SW3 for adjustable torque wrench	
2.000	CW16	12748601000	62	12148044800	KLSS0714C	DTQ50140	BTQSW3L90



Digitally access spare parts and accessories information to ensure you keep your operation running.

Visit kenametal.com/novo and download today. It's Free!



Online Catalogue

Can't find your paper copy of our catalogue anymore?
No worries. Go to catalogs.kennametal.com to see what's out there.

Search for what you need, watch a video, and share pages with others, all from one site! Go to catalogs.kennametal.com, and if you want to check it out on your mobile device, just download the FREE app for iOS or Android™.

1 Search for what you need

2 Watch videos

3 Share with others

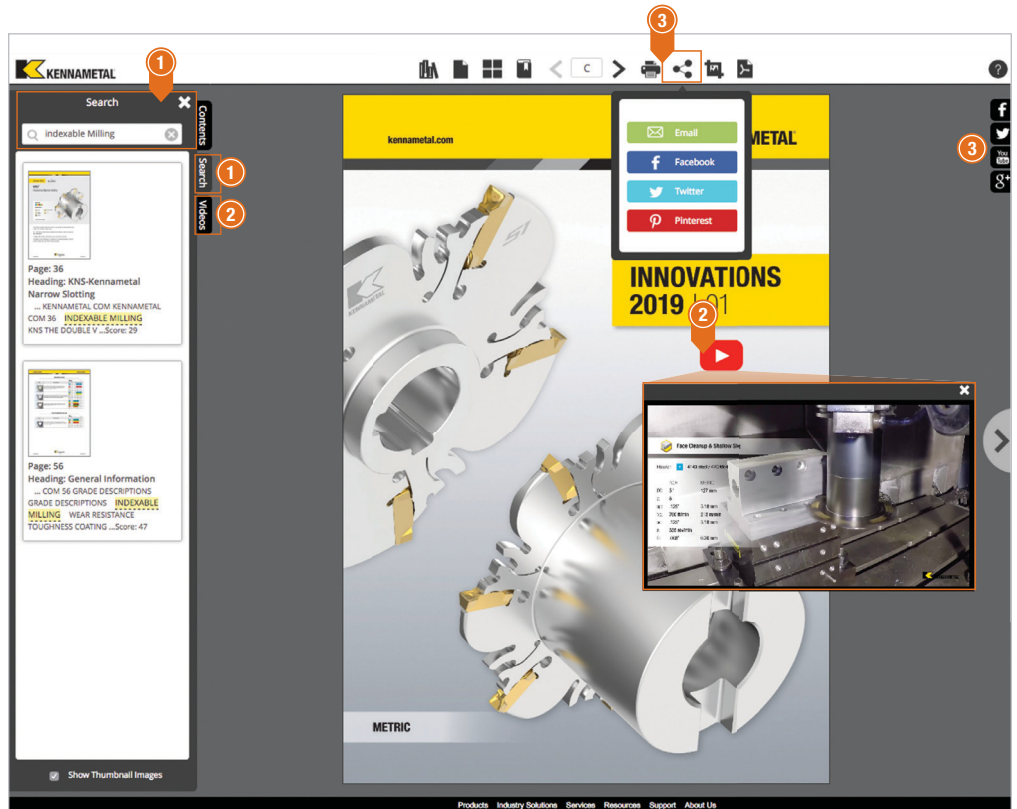

Check out our new catalogue app.
Available in the Google Play™ Store or
the App Store®



Mill 4™ -12KT

Tangential Shoulder Milling

Materials



Applications



Shoulder Milling

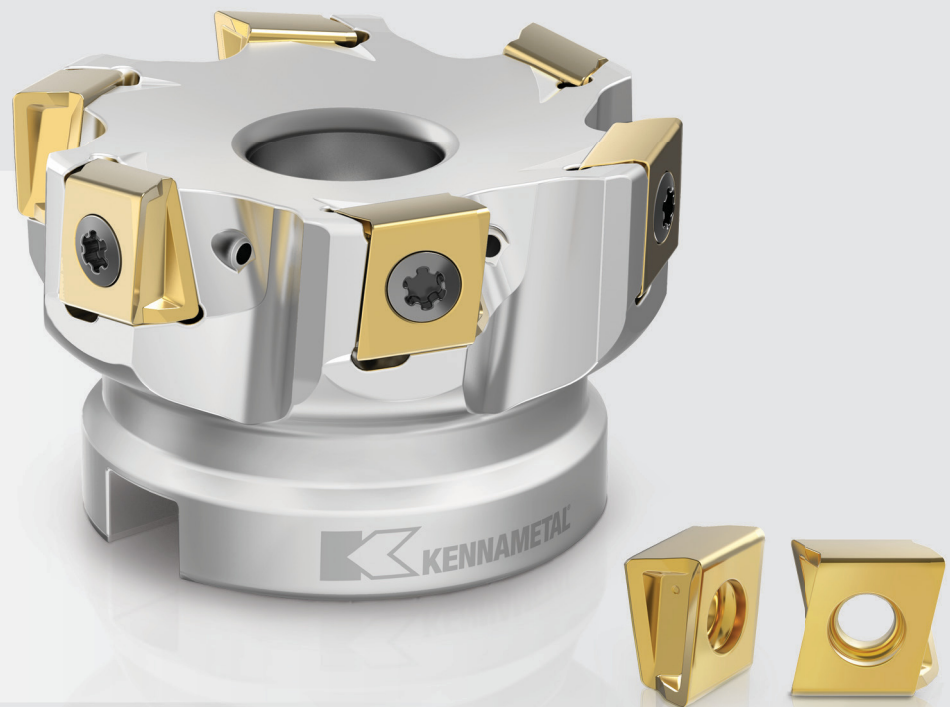

kenametal.com/Mill4-12KT

Mill 4-12KT requires up to 15% less horsepower, enabling increased feed rates, even on small machines.

The patented insert design — featuring a triangular shaped margin — provides unprecedented stability in steel and cast iron applications.

Excellent floor finishes due to minimal axial runout.

With 7 grades, 7 corner radii, and depth-of-cut range up to 12mm, the programme offers versatility to cover many shoulder milling applications.

Patented margin design ensures unprecedented stability.

Tangentially mounted inserts give easy access to insert locking screws.



Coarse and medium pitch cutters with internal coolant supply.

Strong cutter body and strong cutting edges due to tangential design concept.

Comparison

Radially Mounted







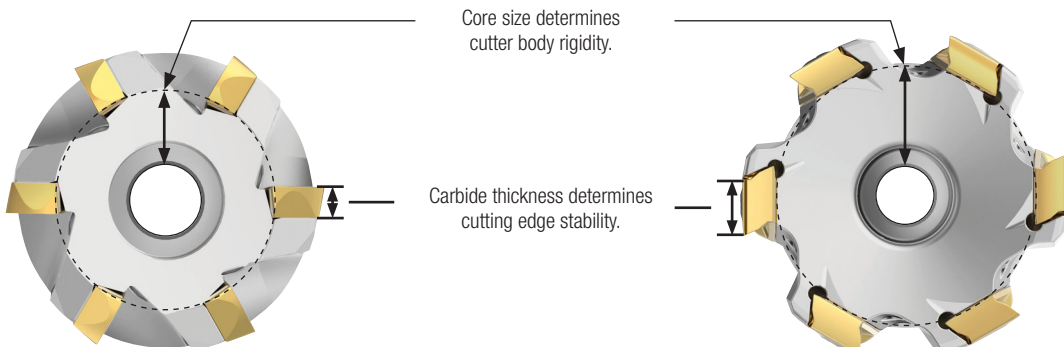



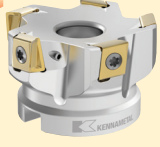







- Requires large pocket; reduces the core size of the cutter.
- Allows very small diameter cutter bodies.
- Access to insert screw can be tough.

Tangentially Mounted

- A shallow pocket allows for large core size of the cutter.
- Very strong cutting edge.
- Easy access to insert screw.





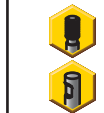







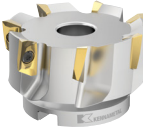
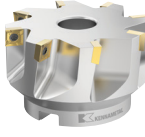
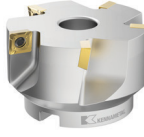
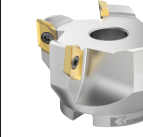
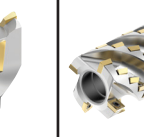





SHOULDER MILLING • TOOL SELECTION GUIDE

	Shoulder Milling				
	Mill 4™-12 ^{KT}	Mill 4-11™	Mill 4-15™	Mill 1-10™	Mill 1-14™
	 				
Page	6	T2*	T12*	T28*	T46*
Main operation					
Workpiece materials					
Primary	P K	P M K N S	P M K N S	P M K N S	P M K N S
Secondary	M S				
Cutter diameter [D1]	50–200mm	16–80mm	25–160mm	16–100mm	20–160mm
Maximum cutting depth [Ap1 max]	12mm	11mm	15,5mm	9,9mm	14,3mm
Insert size IC	13mm	12,16mm	17mm	12mm	17,5mm
Number of inserts per cutter [Z]	4–22	2–10	2–18	2–12	2–12
Number of flutes per cutter [ZU]	4–22	2–10	2–18	2–12	2–12
Internal coolant	✓	✓	✓	✓	✓
Additional operations					
Connection Style Machine Side (CSMS)					
Fits regular shell mill adaptors	✓	✓	✓	✓	✓
Pilot diameter flange mount extension	–	–	–	–	–
Flange mount size	–	–	–	–	–
Cutting edges	4	4	4	2	2
Corner radius for inserts on 1st row	0,4–3,1mm	0,4–1,6mm	0,4–2,0mm	0,2–3,1mm	0,2–4,0mm
Corner radius for inserts after 1st row	–	–	–	–	–

* See page in the Kennametal Master Catalogue 2018 • Volume Two • Rotating Tools • A-16-05217.

** See page in the Kennametal Innovations Catalogue 2019 | 02 • A-18-05789.











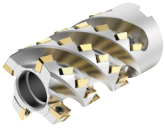
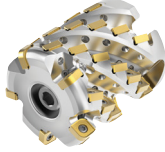
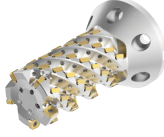





SHOULDER MILLING • TOOL SELECTION GUIDE

	Shoulder Milling				
	Mill 1-18™	KSSM™ 90° • 10mm	KSSM 90° • 12mm	5720VZ16	5230VS09
					
Page	T68*	T96*	T102*	T84*	T114*
Main operation					
Workpiece materials					
Primary	P M K N S	P M K N S	P M K N S	N	P M S
Secondary					
Cutter diameter [D1]	25–160mm	25–100mm	50–200mm	25–80mm	50mm
Maximum cutting depth [Ap1 max]	18mm	6,6mm	9,2mm	16mm	51–80mm
Insert size IC	21,75mm	10mm	12mm	23mm	9mm
Number of inserts per cutter [Z]	2–12	2–10	3–14	2–5	51–80
Number of flutes per cutter [ZU]	2–12	2–10	3–14	2–5	4
Internal coolant	✓				
Additional operations					
Connection Style Machine Side (CSMS)					
Fits regular shell mill adaptors	✓	✓	✓	✓	✓
Pilot diameter flange mount extension	–	–	–	–	–
Flange mount size	–	–	–	–	–
Cutting edges	2	4	4	2	4
Corner radius for inserts on 1st row	0,4–6,4mm	0,4–2,0mm	0,4–6,4mm	0,3–6,0mm	0,8mm
Corner radius for inserts after 1st row	–	–	–	–	–

* See page in the Kennametal Master Catalogue 2018 • Volume Two • Rotating Tools • A-16-05217.

** See page in the Kennametal Innovations Catalogue 2019 | 02 • A-18-05789.

SHOULDER MILLING • TOOL SELECTION GUIDE

	Shoulder Milling		
	5230VS12	HARVI™ Ultra 8X	
			
Page	T118*	T80**	T80**
Main operation			
Workpiece materials			
Primary	P M S	S	S
Secondary			
Cutter diameter [D1]	63–100mm	50–80mm	50–80mm
Maximum cutting depth [Ap1 max]	57–133mm	50–102mm	100–133mm
Insert size IC	12mm	10 & 12mm	10 & 12mm
Number of inserts per cutter [Z]	24–84	15–50	40–55
Number of flutes per cutter [ZU]	4–6	3–5	4–5
Internal coolant		✓	✓
Additional operations		   	   
Connection Style Machine Side (CSMS)			
Fits regular shell mill adaptors	✓	✓	✓
Pilot diameter flange mount extension	–	22–32mm	–
Flange mount size	–	BTF46	BTF46
Cutting edges	4	8 / 4	8 / 4
Corner radius for inserts on 1st row	1,2mm	0,8mm / 1,6–6,4mm	0,8mm / 1,6–6,4mm
Corner radius for inserts after 1st row	–	0,8mm	0,8mm

SELECTION STEPS

* See page in the Kennametal Master Catalogue 2018 • Volume Two • Rotating Tools • A-16-05217.

** See page in the Kennametal Innovations Catalogue 2019 | 02 • A-18-05789.

MILL 4™ -12^{KT} • CATALOGUE NUMBERING SYSTEM • CUTTERS

Each character in our catalogue number signifies a specific trait of that product. Use the following key columns and corresponding images to easily identify which attributes apply.

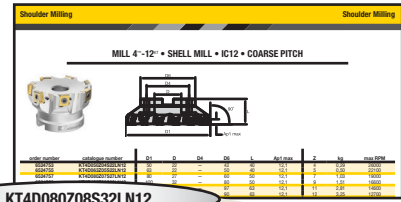

KT4D080Z08S32LN12

KT4

Mill 4-12^{KT}

D080

Cutter Diameter

Z08

Number of Teeth

S32

Connection Style Machine Side (CSMS)

S = Shell Mills

LN12

Insert Style and IC

MILL 4™ -12^{KT} • CATALOGUE NUMBERING SYSTEM • INSERTS

Each character in our catalogue number signifies a specific trait of that product. Use the following key columns and corresponding images to easily identify which attributes apply.

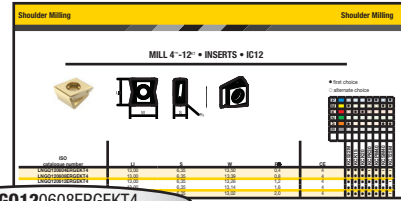

LNGQ120608BERGEK4

L

Insert Shape

- A** Parallelogram 85°
- C** Rhomboid 80°
- E** 75°
- H** Hexagon 120°
- L** Rectangular 90°
- O** Octagon 135°
- R** Round
- S** Square 90°
- T** Triangular 60°
- X** Kennametal Standard Form

N

Insert Clearance Angle

- A** 3°
- B** 5°
- C** 7°
- D** 15°
- E** 20°
- F** 25°
- G** 30°
- N** 0°
- P** 11°

G

Tolerance Class

Indexable inserts with facets/wipers

Indexable inserts with corner radii

Insert thickness

Q

Geometry and Clamping Type

12

Size

"L" for shapes							
A	C	T	R	O	C	H	E
6.00	-	-	06	-	-	-	-
6.35	06	11	06	02	06	03	06
8.00	-	-	08	-	-	-	-
9.52	09	16	09	04	09	05	09
10.00	-	-	10	-	-	-	-
12.00	-	-	12	-	-	-	-
12.70	12	22	12	05	12	07	13
15.88	15	27	15	06	16	09	16
16.00	-	-	16	-	-	-	-
19.05	19	33	19	07	19	11	19
20.00	-	-	20	-	-	-	-
25.00	-	-	25	-	-	-	-
25.40	25	44	25	10	25	14	26

For shapes A, L, and X, see position #1; use length of leading cutting edge.

tolerance class	tolerance on "A"	tolerance on "M"	tolerance on "T"	tolerance class	tolerance on "A"	tolerance on "M"	tolerance on "T"
A	0.025	0.005	0.025	J	0.05-0.13*	0.005	0.025
B	0.025	0.005	0.13	K	0.05-0.13*	0.013	0.025
C	0.025	0.013	0.025	L	0.05-0.13*	0.025	0.025
D	0.025	0.013	0.13	M	0.05-0.10*	0.05-0.25*	0.13
E	0.025	0.025	0.025	N	0.05-0.10*	0.05-0.25*	0.025
F	0.013	0.005	0.025	P**	0.038	0.038	0.038
G	0.025	0.025	0.13	U	0.08-0.25*	0.13-0.30*	0.13
H	0.013	0.013	0.025				

*See table below for tolerances according to insert size and class.
**Kennametal standard only.

A	tolerances on "A"		tolerances on "M"	
	classes J, K, L, M, N	class U	classes M & N	class U
4.76-10.00	0.051	0.076	0.076	0.127
11.11-14.29	0.076	0.127	0.127	0.203
15.00-20.64	0.102	0.178	0.152	0.279
22.00-31.16	0.127	0.254	0.178	0.381
31.75-35.00	0.152	0.254	0.203	0.381

symbol	hole	shape of hole	chipbreaker	shape of insert's section
N	without		without	
R			single sided	
F			double sided	
A	cylindrical hole		without	
M			single sided	
G			double sided	
W	partly cylindrical hole, 40-60° countersink		without	
T			single sided	
Q	partly cylindrical hole, 40-60° double countersink		without	
U			double sided	
B	partly cylindrical hole, 70-90° countersink		without	
H			single sided	
C	partly cylindrical hole, 70-90° double countersink		without	
J			double sided	
X	special design			

MILL 4™ -12^{KT} • CATALOGUE NUMBERING SYSTEM • INSERTS

(continued)

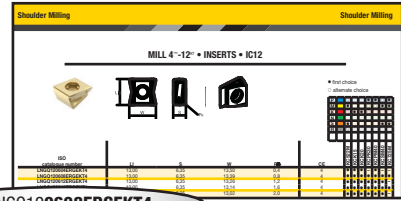

LNGQ120608ERGEKT4

06

Thickness

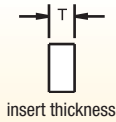

T	
2,38	02
3,18	03
3,97	T3
4,76	04
5,56	05
6,35	06
7,94	07

08

Corner Configuration

E

Cutting Edge Form

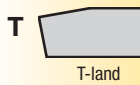
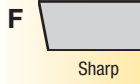

R

Insert Hand

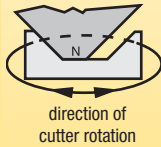
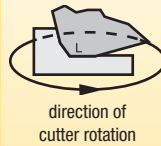
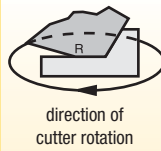

G

Edge Prep Size

E

Rake Face Angle

KT4

Mill4-12^{KT}

radius					
MO	round insert	If letter is replaced by number(s), refer to table for radius "r".			
01	0,1mm				
02	0,2mm				
04	0,4mm				
05	0,5mm				
08	0,8mm				
10	1,0mm				
12	1,2mm			lead angle K	
15	1,5mm			A	45°
16	1,6mm			D	60°
24	2,4mm	E	75°		
32	3,2mm	P	90°		

- L** = Light — sharp or lightly honed and/or T-land
- G** = General — medium hone and/or T-land
- H** = Heavy — large hone and/or T-land

N	A	B	C	P	D	E	F	G
0° or less	3°	5°	7°	11°	15°	20°	25°	30°

Nominal or average angle of rake on insert face at leading cutting edge before edge prep and before installation.

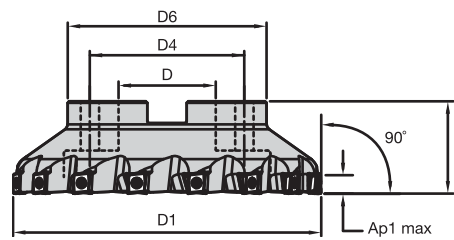
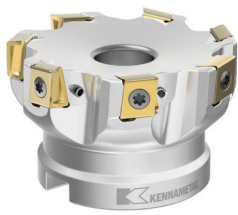
MILL 4™ -12^{KT} • COARSE PITCH • IC12 • SHELL MILL

order number	catalogue number	D1	D	D4	D6	L	Ap1 max	Z	kg	max RPM
6524753	KT4D050Z04S22LN12	50	22	—	42	40	12,1	4	0,29	26000
6524755	KT4D063Z05S22LN12	63	22	—	50	40	12,1	5	0,50	22100
6524757	KT4D080Z07S27LN12	80	27	—	60	50	12,1	7	1,03	19000
6524759	KT4D100Z09S32LN12	100	32	—	80	50	12,1	9	1,51	16600
6524761	KT4D125Z11S40LN12	125	40	—	97	63	12,1	11	2,81	14600
6524763	KT4D160Z12S40LN12	160	40	67	90	63	12,1	12	3,25	12700
6524765	KT4D200Z16S60LN12	200	60	102	130	63	12,1	16	5,56	11200

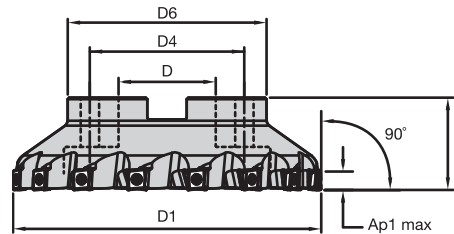
MILL 4-12^{KT} • MEDIUM PITCH • IC12 • SHELL MILL

order number	catalogue number	D1	D	D4	D6	L	Ap1 max	Z	kg	max RPM
6524769	KT4D050Z05S22LN12	50	22	—	42	40	12,1	5	0,30	26000
6524770	KT4D063Z06S22LN12	63	22	—	50	40	12,1	6	0,51	22100
6524771	KT4D080Z08S27LN12	80	27	—	60	50	12,1	8	1,05	19000
6524772	KT4D100Z11S32LN12	100	32	—	80	50	12,1	11	1,55	16600
6524773	KT4D125Z14S40LN12	125	40	—	97	63	12,1	14	2,86	14600
6524774	KT4D160Z16S40LN12	160	40	67	90	63	12,1	16	3,31	12700
6524775	KT4D200Z22S60LN12	200	60	102	130	63	12,1	22	5,65	11200



74

76

11

4

65

MILL 4™ -12KT • INSERTS • IC12

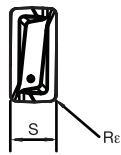
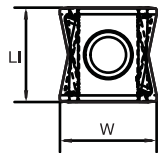

- first choice
- alternate choice

P	●	○		●	●	○	○
M	●					○	○
K	○	○	●	○			
N	○						
S	●						●
H	○						

ISO catalogue number	LI	S	W	Rφ	CE	KC52M	KCK15	KCK20	KCPK30	KCPM40	KCSM40	KC725M
LNGQ120604ERGEKT4	13,00	6,35	13,50	0,4	4	●	●	●	-	●	●	-
LNGQ120608ERGEKT4	13,00	6,35	13,39	0,8	4	●	●	●	-	●	●	-
LNGQ120612ERGEKT4	13,00	6,35	13,26	1,2	4	●	●	●	-	●	●	-
LNGQ120616ERGEKT4	13,00	6,35	13,14	1,6	4	●	●	●	-	●	●	-
LNGQ120620ERGEKT4	13,00	6,35	13,02	2,0	4	●	●	●	-	●	●	-
LNGQ120624ERGEKT4	13,00	6,35	12,89	2,4	4	-	-	-	●	●	●	-
LNGQ120631ERGEKT4	13,00	6,35	12,63	3,2	4	-	-	-	●	●	●	-

74	76	12	4	65



MILL 4™ -12KT • INSERT SELECTION GUIDE • IC12

Material Group	Light Machining (Light geometry)		General Purpose		Heavy Machining (Strong geometry)	
	wear resistance				toughness	
	Geometry	Grade	Geometry	Grade	Geometry	Grade
P1-P2	.E..GE	KC522M	.E..GE	KCPM40	.E..GE	KCPM40
P3-P4	.E..GE	KC522M	.E..GE	KCPM40	.E..GE	KCPM40
P5-P6	.E..GE	KC522M	.E..GE	KCPK30	.E..GE	KCPM40
M1-M2	.E..GE	KC522M	.E..GE	KCSM40	.E..GE	KCPM40
M3	.E..GE	KC522M	.E..GE	KCSM40	.E..GE	KCPM40
K1-K2	.E..GE	KCK15	.E..GE	KCK15	.E..GE	KCPK30
K3	.E..GE	KCK20	.E..GE	KCK20	.E..GE	KCPK30
N1-N2	-	-	-	-	-	-
N3	-	-	-	-	-	-
S1-S2	.E..GE	KC522M	.E..GE	KCSM40	.E..GE	KCSM40
S3	.E..GE	KC522M	.E..GE	KCSM40	.E..GE	KCSM40
S4	.E..GE	KC522M	.E..GE	KCSM40	.E..GE	KCSM40
H1	-	-	-	-	-	-

MILL 4-12KT • RECOMMENDED STARTING FEEDS [MM] • IC12

Insert Geometry	Recommended Starting Feed per Tooth (Fz) in Relation to % of Radial Engagement (ae)														Insert Geometry	
	Light Machining			General Purpose			Heavy Machining									
	10%	20%	30%	40%	50-100%											
.E..GE	0,12	0,33	0,59	0,09	0,25	0,44	0,08	0,22	0,38	0,07	0,20	0,36	0,07	0,20	0,35	.E..GE

NOTE: Use "Light Machining" values as starting feed rate.

MILL 4-12KT • RECOMMENDED STARTING SPEEDS [M/MIN] • IC12

Material Group		KC522M			KCK15			KCK20			KCPK30			KCPM40			KCSM40			KC725M		
P	1	329	287	268	-	-	-	-	-	-	453	396	369	296	259	244	-	-	-	260	230	215
	2	274	241	201	-	-	-	-	-	-	280	253	229	250	216	180	-	-	-	220	190	160
	3	253	213	177	-	-	-	-	-	-	253	229	207	229	195	158	-	-	-	200	170	140
	4	226	186	149	-	-	-	-	-	-	189	175	158	204	171	134	-	-	-	180	150	120
	5	186	168	149	-	-	-	-	-	-	259	232	210	171	155	134	134	99	70	150	135	120
	6	165	125	101	-	-	-	-	-	-	158	137	116	149	116	91	114	184	50	130	100	80
M	1	204	180	165	-	-	-	-	-	-	207	183	157	195	171	155	259	184	114	170	150	135
	2	186	158	131	-	-	-	-	-	-	186	162	140	174	149	125	230	171	105	155	130	110
	3	140	122	94	-	-	-	-	-	-	145	131	116	131	116	91	191	134	85	115	100	80
K	1	229	207	183	421	383	340	330	220	150	294	267	238	-	-	-	-	-	-	-	-	-
	2	180	162	149	334	297	277	250	180	125	235	210	192	-	-	-	-	-	-	-	-	-
	3	149	134	122	280	248	229	220	150	120	197	175	162	-	-	-	-	-	-	-	-	-
N	1	-	-	-	-	-	-	-	-	-	-	-	-	-	-	-	-	-	-	-	-	-
	2	-	-	-	-	-	-	-	-	-	-	-	-	-	-	-	-	-	-	-	-	-
	3	-	-	-	-	-	-	-	-	-	-	-	-	-	-	-	-	-	-	-	-	-
S	1	40	37	27	-	-	-	-	-	-	-	-	-	40	34	30	61	44	27	35	30	25
	2	40	37	27	-	-	-	-	-	-	-	-	-	40	34	30	55	40	26	35	30	25
	3	52	40	27	-	-	-	-	-	-	-	-	-	49	40	30	64	46	29	45	35	25
	4	70	52	37	-	-	-	-	-	-	-	-	-	64	49	34	90	66	41	60	45	30
H	1	119	91	70	-	-	-	-	-	-	-	-	-	-	-	-	-	-	-	-	-	-

NOTE: FIRST choice starting speeds are in bold type.
Do not exceed max RPM. Reduce speed if necessary.



Catalogue App

Browse Pages

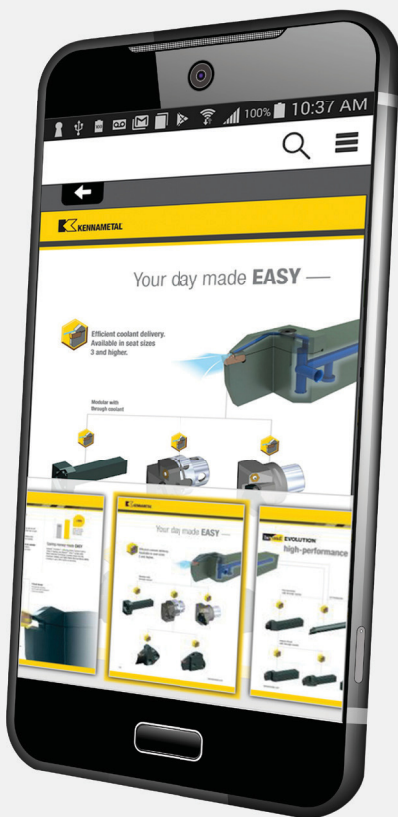

Search Products

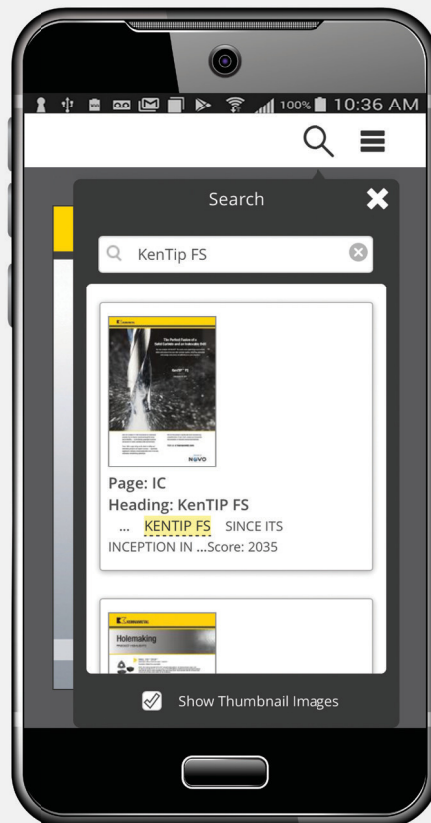

Watch a Video



Check out our new catalogue app.
Available in the Google Play™ Store
or the App Store®

OR VISIT CATALOGS.KENNAMETAL.COM TODAY.

HARVI™ Series

High-Performance Solid End Milling

Materials



Applications



Slotting



Helical Interpolation



3D Profiling



Plunge Milling



Side Milling/
Shoulder Milling



Trochoidal Milling



Ramping



Trochoidal Milling:
Ball Nose



HARVI II Trochoidal • TCDE 5 x D
See page 21.

Kennametal.com/HARVI

The HARVI series offers exceptionally high feed and speed rate capabilities resulting in unmatched metal removal rates.

HARVI I

For roughing and finishing with one tool.

HARVI I Taper Ball Nose

Designed for roughing and finishing in 5-axis machining.

HARVI II

For roughing and finishing with highest metal removal rate capability.



HARVI II Trochoidal

Designed for dynamic milling in stainless, titanium, and steel using CAM tool path generation software. With chip splitters. Now available in 3 x D and 5 x D.



Intermediate diameters are available upon request as custom solutions.

Pullout protection through Safe-Lock™ by Haimer® available.

Proprietary, unequal flute spacing reduces vibration and improves surface finish.

Unique core design provides exceptional tool stability.

HARVI II Long

Ideal for finishing long walls with exceptional straightness. Up to 5 x D.





















HARVI III

With eccentric relief. Perfect for semi-finishing and finishing of titanium.

HARVI III Taper Ball Nose

Designed for 5-axis machining. Offers same feed-per-tooth rates as 4-fluted tools.



























HARVI™ • TOOL SELECTION GUIDE

	HIGH-PERFORMANCE (HP) ROUGHING & FINISHING				
	HARVI™ I	HARVI I	HARVI I	HARVI I Chipbreaker	HARVI I Extended Reach
					
Series	F4AS...DL	UADE	F4AS.. WM-WX-WL/UBDE	F4BS.. WM-WX-WL	UADE
Page	P16*	P17*	P18*	P19*	P20*
Tool type					
Rougher	●	●	●	●	●
Finisher	○	○	○	○	○
Chamfering					
Main operation					
Workpiece material					
Primary	P M K	P M K	P M K S	P M K	P M K
Secondary	S H	S H	H	H	H
Corner style					
Corner radius [R _e]	—	—	0,50–6mm	0,50–4mm	—
Corner chamfer width [BCH]	0,40–0,50mm	0,40–0,50mm	—	—	0,40–0,50mm
Cutter diameter [D1]	4–25mm	4–25mm	6–25mm	6–25mm	6–20mm
Length of cut	1,8–3 x D1	3–4 x D	2–2,5 x D1	1,5 x D1	2 x D1
Maximum cutting depth [A _{p1} max]	12–45mm	11–45mm	9–37,5mm	9–37,5mm	12–40mm
Flute helix angle	38°	38°	38°	38°	38°
Number of flutes [ZU]	4	4	4	4	4
Centre cutting	✓	✓	✓	✓	✓
Additional operations					

* See page in the Kennametal Master Catalogue 2018 • Volume Two • Rotating Tools, A-16-05217.

- Primary
- Secondary































HARVI™ • TOOL SELECTION GUIDE

	HP FINISHING & ROUGHING					
	HARVI™ I Ball Nose	HARVI I Taper Ball Nose	HARVI II	HARVI II	HARVI II Trochoidal	HARVI II Trochoidal
						
Series	F4AW..WL-WX	F4AW..AWL38-AWX38	UCDE	UDDE	TCDE 3 x D	TCDE 5 x D
Page	P21*	P22*	P30*	P31-P32*	P42*	24
Tool type						
Rougher	●	●	○	○	○	○
Finisher	○	○	●	●	●	●
Chamfering						
Main operation						
Workpiece material						
Primary	P M K		P M K S	P K S	M S	M S
Secondary	H	P M S H	H	H	P K H	P K H
Corner style			 	 		
Corner radius [R _e]	—	—	0,25–0,75mm	0,20–6mm	0,50–1mm	0,5–1mm
Corner chamfer width [BCH]	—	—	—	—	—	—
Cutter diameter [D1]	6–16mm	4–10mm	4–25mm	6–25mm	8–25mm	8–25mm
Length of cut	1 x D1	5–7 x D	1,8–2,7 x D1	1,8–2,2 x D1	3 x D	5 x D
Maximum cutting depth [A _{p1} max]	6–16mm	30,5–61mm	11–45mm	13–45mm	24–75mm	40–125mm
Flute helix angle	38°	38°	38°	38°	40°	40°
Number of flutes [ZU]	4	4	5	5	5	5
Centre cutting	✓	✓				
Additional operations						

* See page in the Kennametal Master Catalogue 2018 • Volume Two • Rotating Tools, A-16-05217.

- Primary
- Secondary

HARVI™ • TOOL SELECTION GUIDE

	HP FINISHING AND SEMI-FINISHING		HP FINISHING & ROUGHING			
	HARVI™ II Long	HARVI II Long	HARVI III	HARVI III	HARVI III Ball Nose	HARVI III Taper Ball Nose
						
Series	UGDE 3 x D	UGDE 5 x D	UJDE	UJDE with neck	UJBE	UJBE
Page	P36*	P37*	P48*	P49*	P54*	P62*
Tool type						
Rougher			○	○	○	
Finisher	●	●	●	●	●	●
Chamfering						
Main operation						
Workpiece material						
Primary	P M S	P M S	M S	M S	M S	M S
Secondary	K H	K H	P H	P H	P H	P H
Corner style			 	 		
Corner radius [R _e]	0,20–6mm	0,20–6mm	0,50–0,75mm	0,50–6mm	—	—
Corner chamfer width [BCH]	—	—	—	—	—	—
Cutter diameter [D1]	6–25mm	6–25mm	10–25mm	10–25mm	10–20mm	4–10mm
Length of cut	3 x D	5 x D	2 x D	3 x D	1 x D1	5–7 x D
Maximum cutting depth [Ap1 max]	18–75mm	30–125mm	22–45mm	22–45mm	10–20mm	26–39mm
Flute helix angle	43°	43°	38°	38°	38°	38°
Number of flutes [ZU]	5	5	6	6	6	6
Centre cutting			✓	✓	✓	✓
Additional operations			 	 	 	 

* See page in the Kennametal Master Catalogue 2018 • Volume Two • Rotating Tools, A-16-05217.

- Primary
- Secondary

HARVI™ • CATALOGUE NUMBERING SYSTEM

Each character in our catalogue number signifies a specific trait of that product. Use the following key columns and corresponding images to easily identify which attributes apply.

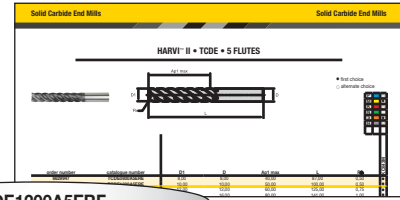

TCDE1200A5ERF

TC	D	E	1200	A	5	E	R	F
Series	End Mill Shape	Helix Angle	Diameter (mm/inch)	Shank Style	Number of flutes	Length-of-Cut	Feature	Radius
<p>TC = HARVI II Trochoidal</p> <p>UA = HARVI I</p> <p>UB = HARVI I</p> <p>UC = HARVI II</p> <p>UD = HARVI II</p> <p>UG = HARVI II</p> <p>UJ = HARVI III</p>	<p>B = Ball Nose RH</p> <p>D = Square End RH</p>	<p>E = 36-40</p>		<p>A = metric – Plain</p> <p>B = metric – Weldon®</p> <p>E = metric – Plain and Safe-Lock™</p>	<p>4</p> <p>5</p> <p>6</p>	<p>A = Short</p> <p>B = Regular</p> <p>C = Long</p> <p>D = Extra Long</p> <p>E = Extra Extra Long</p> <p>F = Extra Extra Extra Long</p>	<p>B = Aerospace</p> <p>H = Chamfer</p> <p>L = Extended Reach, Necked</p> <p>N = Necked</p> <p>Q = Necked and Radius</p> <p>R = Radius</p> <p>S = Square (Sharp)</p> <p>U = Necked and Sharp</p>	<p>A = Metric – 0,2mm</p> <p>B = Metric – 0,25mm</p> <p>C = Metric – 0,3mm</p> <p>D = Metric – 0,4mm</p> <p>E = Metric – 0,5mm</p> <p>F = Metric – 0,75mm</p> <p>G = Metric – 1,0mm</p> <p>H = Metric – 1,25mm</p> <p>J = Metric – 1,5mm</p> <p>K = Metric – 2,0mm</p> <p>L = Metric – 2,5mm</p> <p>M = Metric – 3,0mm</p> <p>N = Metric – 4,0mm</p> <p>P = Metric – 6,0mm</p> <p>Q = Metric – 5,0mm</p>

HARVI™ II • TCDE • 5 FLUTES

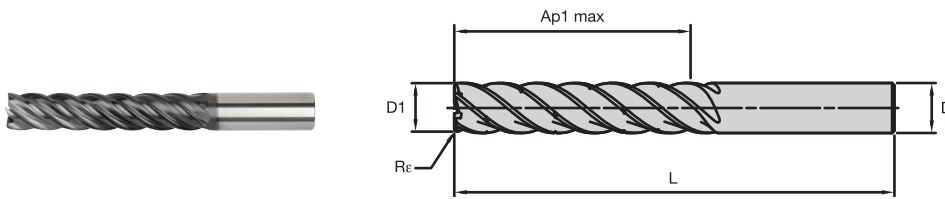

● first choice
○ alternate choice

P	<input type="radio"/>
M	<input checked="" type="radio"/>
K	<input type="radio"/>
N	<input type="radio"/>
S	<input type="radio"/>
H	<input type="radio"/>

KC643M

order number	catalogue number	D1	D	Ap1 max	L	Rc
6629947	TCDE0800A5ERE	8,00	8,00	40,00	87,00	0,50
6629948	TCDE1000A5ERE	10,00	10,00	50,00	100,00	0,50
6629949	TCDE1200A5ERF	12,00	12,00	60,00	125,00	0,75
6629950	TCDE1600A5ERG	16,00	16,00	80,00	141,00	1,00
6629971	TCDE2000A5ERG	20,00	20,00	100,00	170,00	1,00
6629972	TCDE2500A5ERG	25,00	25,00	125,00	200,00	1,00



HARVI II • TCDE • 5 FLUTES • APPLICATION DATA • A_e 10% OF D1

Material Group	Side Milling (A)		KC643M		Recommended feed per tooth (fz = mm/th) for side milling (A).								
	A		Cutting Speed – vc m/min		D1 – Diameter								
	ap	ae	min	max	mm	8,0	10,0	12,0	16,0	20,0	25,0		
	ap max	0,1 x D			fz								
P	0	Ap max	0,1 x D	150	–	440	fz	0,072	0,086	0,099	0,121	0,137	0,149
	1	Ap max	0,1 x D	150	–	440	fz	0,072	0,086	0,099	0,121	0,137	0,149
	2	Ap max	0,1 x D	140	–	418	fz	0,072	0,086	0,099	0,121	0,137	0,149
	3	Ap max	0,1 x D	120	–	352	fz	0,060	0,073	0,084	0,105	0,121	0,137
	4	Ap max	0,1 x D	90	–	330	fz	0,054	0,065	0,075	0,092	0,106	0,117
	5	Ap max	0,1 x D	60	–	220	fz	0,048	0,058	0,067	0,084	0,097	0,109
M	6	Ap max	0,1 x D	50	–	165	fz	0,040	0,048	0,056	0,068	0,078	0,085
	1	Ap max	0,1 x D	90	–	253	fz	0,060	0,073	0,084	0,105	0,121	0,137
K	2	Ap max	0,1 x D	60	–	176	fz	0,048	0,058	0,067	0,084	0,097	0,109
	3	Ap max	0,1 x D	60	–	154	fz	0,040	0,048	0,056	0,068	0,078	0,085
S	1	Ap max	0,1 x D	120	–	330	fz	0,072	0,086	0,099	0,121	0,137	0,149
	2	Ap max	0,1 x D	110	–	308	fz	0,060	0,073	0,084	0,105	0,121	0,137
H	3	Ap max	0,1 x D	110	–	286	fz	0,048	0,058	0,067	0,084	0,097	0,109
	1	Ap max	0,1 x D	50	–	198	fz	0,060	0,073	0,084	0,105	0,121	0,137
H	2	Ap max	0,1 x D	25	–	88	fz	0,032	0,038	0,045	0,056	0,065	0,074
	3	Ap max	0,1 x D	25	–	88	fz	0,032	0,038	0,045	0,056	0,065	0,074
H	4	Ap max	0,1 x D	50	–	132	fz	0,044	0,053	0,062	0,077	0,089	0,100
	1	Ap max	0,1 x D	80	–	308	fz	0,054	0,065	0,075	0,092	0,106	0,117
H	2	Ap max	0,1 x D	70	–	264	fz	0,040	0,048	0,056	0,068	0,078	0,085

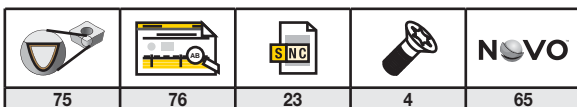
NOTE: Lower value of cutting speed is used for high stock removal applications or for higher hardness (machinability) within group.
Higher value of cutting speed is used for finishing applications or for lower hardness (machinability) within group.
Above parameters are based on ideal conditions. For smaller taper machining centres, please adjust parameters accordingly on >12mm diameter.
For better surface finish, reduce feed per tooth.





HARVI™ II • TCDE • 5 FLUTES • APPLICATION DATA • A_ε 5% OF D1

Material Group							Side Milling (A)					
	Side Milling (A)		KC643M				Recommended feed per tooth (fz = mm/th) for side milling (A).					
	A		Cutting Speed – vc m/min				D1 – Diameter					
	ap	ae	min		max	mm	8,0	10,0	12,0	16,0	20,0	25,0
P	0	Ap max 0,05 x D	150	–	540	fz	0,097	0,117	0,134	0,163	0,185	0,200
	1	Ap max 0,05 x D	150	–	540	fz	0,097	0,117	0,134	0,163	0,185	0,200
	2	Ap max 0,05 x D	140	–	513	fz	0,097	0,117	0,134	0,163	0,185	0,200
	3	Ap max 0,05 x D	120	–	432	fz	0,081	0,098	0,114	0,141	0,164	0,184
	4	Ap max 0,05 x D	90	–	405	fz	0,073	0,087	0,101	0,124	0,143	0,158
	5	Ap max 0,05 x D	60	–	270	fz	0,065	0,078	0,091	0,113	0,131	0,147
M	6	Ap max 0,05 x D	50	–	202,5	fz	0,054	0,065	0,075	0,092	0,105	0,115
	1	Ap max 0,05 x D	90	–	310,5	fz	0,081	0,098	0,114	0,141	0,164	0,184
	2	Ap max 0,05 x D	60	–	216	fz	0,065	0,078	0,091	0,113	0,131	0,147
K	3	Ap max 0,05 x D	60	–	189	fz	0,054	0,065	0,075	0,092	0,105	0,115
	1	Ap max 0,05 x D	120	–	405	fz	0,097	0,117	0,134	0,163	0,185	0,200
	2	Ap max 0,05 x D	110	–	378	fz	0,081	0,098	0,114	0,141	0,164	0,184
S	3	Ap max 0,05 x D	110	–	351	fz	0,065	0,078	0,091	0,113	0,131	0,147
	1	Ap max 0,05 x D	50	–	243	fz	0,081	0,098	0,114	0,141	0,164	0,184
	2	Ap max 0,05 x D	25	–	108	fz	0,043	0,052	0,060	0,075	0,087	0,099
H	3	Ap max 0,05 x D	25	–	108	fz	0,043	0,052	0,060	0,075	0,087	0,099
	4	Ap max 0,05 x D	50	–	162	fz	0,060	0,072	0,084	0,104	0,120	0,135
H	1	Ap max 0,05 x D	80	–	378	fz	0,073	0,087	0,101	0,124	0,143	0,158
	2	Ap max 0,05 x D	70	–	324	fz	0,054	0,065	0,075	0,092	0,105	0,115

NOTE: Lower value of cutting speed is used for high stock removal applications or for higher hardness (machinability) within group.
 Higher value of cutting speed is used for finishing applications or for lower hardness (machinability) within group.
 Above parameters are based on ideal conditions. For smaller taper machining centres, please adjust parameters accordingly on >12mm diameter.
 For better surface finish, reduce feed per tooth.

HARVI II • TCDE • 5 FLUTES • APPLICATION DATA • A_ε 2% OF D1

Material Group							Side Milling (A)					
	Side Milling (A)		KC643M				Recommended feed per tooth (fz = mm/th) for side milling (A).					
	A		Cutting Speed – vc m/min				D1 – Diameter					
	ap	ae	min		max	mm	8,0	10,0	12,0	16,0	20,0	25,0
P	0	Ap max 0,02 x D	150	–	660	fz	0,140	0,168	0,194	0,236	0,267	0,290
	1	Ap max 0,02 x D	150	–	660	fz	0,140	0,168	0,194	0,236	0,267	0,290
	2	Ap max 0,02 x D	140	–	627	fz	0,140	0,168	0,194	0,236	0,267	0,290
	3	Ap max 0,02 x D	120	–	528	fz	0,117	0,142	0,164	0,204	0,236	0,266
	4	Ap max 0,02 x D	90	–	495	fz	0,105	0,126	0,146	0,180	0,206	0,228
	5	Ap max 0,02 x D	60	–	330	fz	0,094	0,113	0,131	0,163	0,189	0,213
M	6	Ap max 0,02 x D	50	–	247,5	fz	0,079	0,095	0,109	0,133	0,152	0,166
	1	Ap max 0,02 x D	90	–	379,5	fz	0,117	0,142	0,164	0,204	0,236	0,266
	2	Ap max 0,02 x D	60	–	264	fz	0,094	0,113	0,131	0,163	0,189	0,213
K	3	Ap max 0,02 x D	60	–	231	fz	0,079	0,095	0,109	0,133	0,152	0,166
	1	Ap max 0,02 x D	120	–	495	fz	0,140	0,168	0,194	0,236	0,267	0,290
	2	Ap max 0,02 x D	110	–	462	fz	0,117	0,142	0,164	0,204	0,236	0,266
S	3	Ap max 0,02 x D	110	–	429	fz	0,094	0,113	0,131	0,163	0,189	0,213
	1	Ap max 0,02 x D	50	–	297	fz	0,117	0,142	0,164	0,204	0,236	0,266
	2	Ap max 0,02 x D	25	–	132	fz	0,062	0,075	0,087	0,109	0,126	0,143
H	3	Ap max 0,02 x D	25	–	132	fz	0,062	0,075	0,087	0,109	0,126	0,143
	4	Ap max 0,02 x D	50	–	198	fz	0,086	0,104	0,121	0,150	0,174	0,196
H	1	Ap max 0,02 x D	80	–	462	fz	0,105	0,126	0,146	0,180	0,206	0,228
	2	Ap max 0,02 x D	70	–	396	fz	0,079	0,095	0,109	0,133	0,152	0,166

NOTE: Lower value of cutting speed is used for high stock removal applications or for higher hardness (machinability) within group.
 Higher value of cutting speed is used for finishing applications or for lower hardness (machinability) within group.
 Above parameters are based on ideal conditions. For smaller taper machining centres, please adjust parameters accordingly on >12mm diameter.
 For better surface finish, reduce feed per tooth.

Turret Adapted Clamping Units



Driven Unit • ER™



Driven Unit • KM™



Static Unit • KM

kennametal.com/TACU

Turret adapted clamping units provide unmatched performance and guaranteed productivity improvement.

Ensure optimised machine utilisation by increasing repeatability and reducing setup times.

Turret adapted clamping units are designed to fit specific machine-tool turret interfaces.

The offering covers various machine models from leading machine-tool builders such as DOOSAN™, HAAS™, HWACHEON™, HYUNDIA WIA, Mazak™, DMG Mori, and OKUMA™.

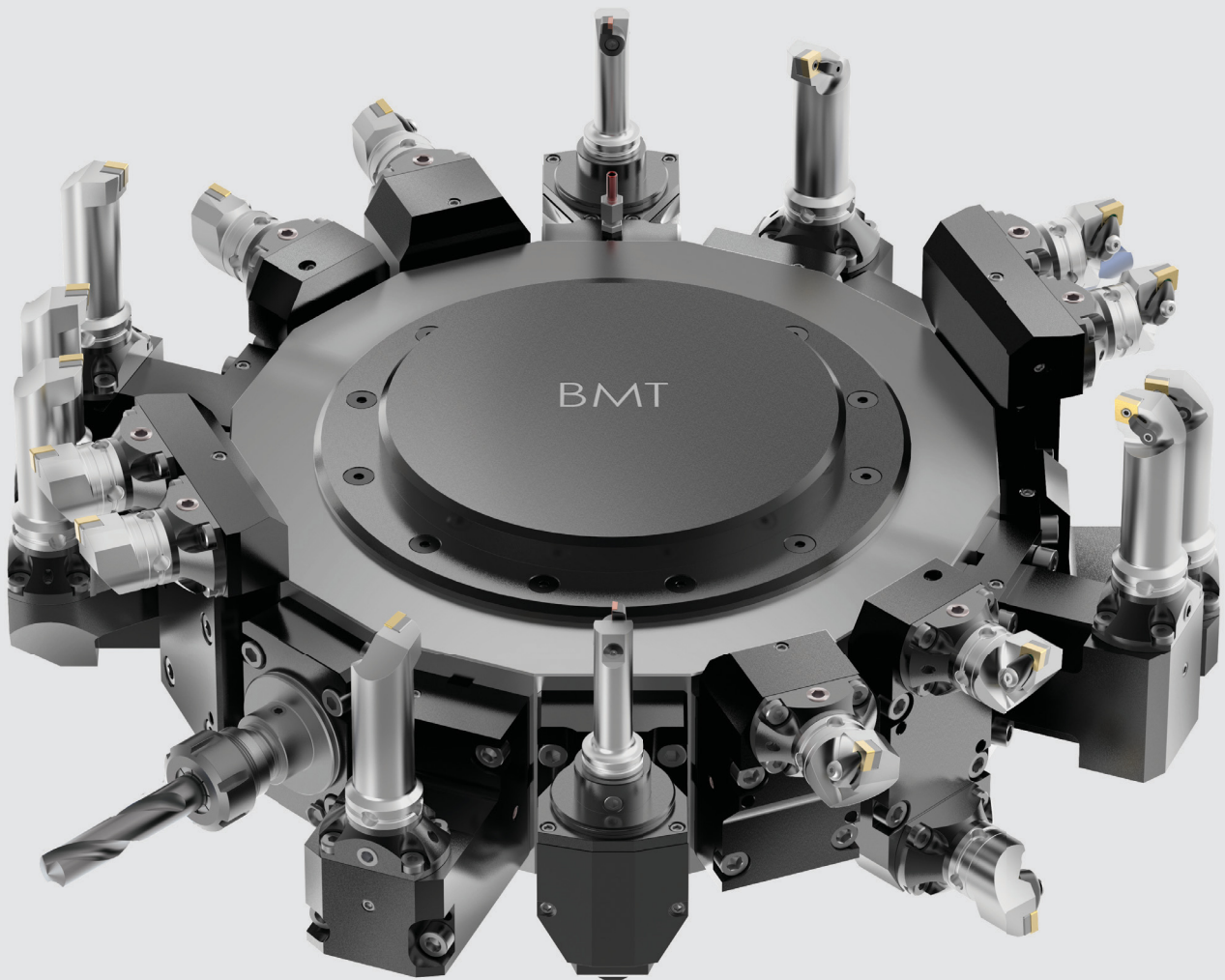

- Standard portfolio features static blocks and driven tools for KM™ sizes 32, 40, 50, and 63.
- **NEW:** Driven tools for ER sizes 25, 32, and 40.
- Driven tools up to 12,000 RPM. Gear ratio 1:1.
- Designed to fit machine-tool specific turret interfaces.
- VDI mounted units for easy handling.
- Bolt mounted units (BMT) for high rigidity.
- Available with internal and external coolant supply.

TACU • TOOL SELECTION GUIDE

- 1 STEP 1: Find machine tool manufacturer.
- 2 STEP 2: Choose machine tool model.
- 3 STEP 3: Find machine mount code (MMC).

1

MACHINE TOOL MANUFACTURER

	DMG MORI	OKUMA™	HAAS™
Machine Tool Model	<ul style="list-style-type: none"> DuraTurn 2050, 2550 MC NL/NLX 1500–2500 (20 Station Turret) NT 3100, 3150, 3200 NT/NTX 1000, 2000 NZ/NZX 1500–2000 (16 Station Turret) DIM 1500 	<ul style="list-style-type: none"> Genos L300 MW/MYW LB/LU 2000–3000 EX M/MY/MW/MYW MULTUS U3000, 4000 2S 	<ul style="list-style-type: none"> ST–20/30, SL–20/30 (BOT Turret)
Machine Mount Code (MMC)	MMC 001 Pages: 55–58	MMC 009 Pages: 62–64	MMC 013 Page: 34
Machine Tool Model	<ul style="list-style-type: none"> NL/NLX 1500–4000 MC/Y/SMC/SY NLX 4000 (High Torque Milling) NZX 2500 (12 Station Turret) 	<ul style="list-style-type: none"> ES L10 Genos L400 LB/LU 2500–3000 EX LB300, LU300 	<ul style="list-style-type: none"> ST–20 (BMT65) ST–20Y (BMT65) ST–25 (BMT65) ST–25Y (BMT65) ST–30 (BMT65) ST–30Y (BMT65) ST–35 (BMT65) ST–35Y (BMT65) DS–30 (BMT65) DS–30Y (BMT65)
Machine Mount Code (MMC)	MMC 002 Pages: 58–61	MMC 013 Page: 64	MMC 036 Pages: 34–36

MAZAK™

Machine Tool Model	<ul style="list-style-type: none"> Quick Turn Nexus 200, 250 M, MY (12 Station Turret) Quick Turn Nexus 200, 250 MS, MSY (12 Station Turret) Super Quadrex 200, 250 M (12 Station Turret) Super Quick Turn 200, 250, M, MY (12 Station Turret) Super Quick Turn 200, 250, MS, MSY (12 Station Turret) 	<ul style="list-style-type: none"> Hyper Quadrex 200, 250 MSY (12 Station Turret) Multiplex 6200, 6200Y, 6250 (12 Station Turret) 	<ul style="list-style-type: none"> Hyper Quadrex 450 M Megaturn Nexus 900 M Quick Turn Nexus 300–450 M, MY Slant Turn Nexus 500, 550 M
Machine Mount Code (MMC)	MMC 016 Pages: 45–47	MMC 017 Pages: 47–49	MMC 018 Pages: 50–51
Machine Tool Model	<ul style="list-style-type: none"> MP430, 630 (12 Station Turret) MP6300, 6300 Y (12 Station Turret) 	<ul style="list-style-type: none"> Quick Turn Smart 100, 150 M S Quick Turn Smart 200, 250 M 	
Machine Mount Code (MMC)	MMC 019 Pages: 51–53	MMC 020 Pages: 53–54	

DOOSAN™ (DAEWOO™) HYUNDAI WIA HWACHEON™

Machine Tool Model	<ul style="list-style-type: none"> Lynx 300M Puma 1500, 2000, 2500 M/Y (12 Station, BMT55) Puma 1500–2500 MS/SY (12 Station, BMT55) Puma 2100 M/MS/Y/SY (24 Station, BMT55) Puma 2100 M/Y (12 Station, BMT55) Puma 230, 240, 280 M/MS/LM Puma MX1600, 2100 ST (BMT55) Puma TL2000, 2500 M Puma TT1500, 1800 MS/SY 	<ul style="list-style-type: none"> L230LMSA LM1600, 1800TTSY SKT160, 180TTMS/TTSY (BMT55) 	<ul style="list-style-type: none"> Cutex 160 MC/SMC (BMT 55)
Machine Mount Code (MMC)	MMC 035 Pages: 30–31	MMC 035 Pages: 41–42	MMC 035 Pages: 37–38
Machine Tool Model	<ul style="list-style-type: none"> Puma 2100, 2600 M/MS/Y/SY (24 Station, BMT65) Puma 2100, 2600 M/MS/Y/SY (12 Station, BMT65) Puma 3100 M/Y/MY (12 Station, BMT65) Puma MX2000, 2500, 2600 T/ST/SY Puma VT450 M, VT450 M–2SP Puma Invertturn 3000 M Puma 300 M/MS Puma TT2000, 2500 MS/SY Puma V400M 	<ul style="list-style-type: none"> SKT200, 250TTM/MS/SY SKT250, 300M/MS L2100SY LM2000, 2500TTM/TTMS/TTSY L300M/MS 	<ul style="list-style-type: none"> Cutex 240 MC/SMC Hi-Tech 200–450 MC/SMC/YMC/YSMC (BMT 65) T2 MC/SMC/YMC/YSMC VT450 MC (BMT65)
Machine Mount Code (MMC)	MMC 036 Pages: 31–33	MMC 036 Pages: 42–44	MMC 036 Pages: 38–40



TACU • CATALOGUE NUMBERING SYSTEM

Each character in our catalogue number signifies a specific trait of that product. Use the following key columns and corresponding images to easily identify which attributes apply.

Turret Adapted Clamping Units		Turret Adapted Clamping Units									
DMG MORI • DRIVEN TOOL AXIAL • KM™ • MMC 001											
Order number	Article number	CSWS	MMC	ER	D	L	L1	width	up	ST	MM
80121P	TACU001KM40DA60648393	40	001	ER	D	124	24	70	100	10	10000
80121R	TACU001KM40DA60648393	40	001	ER	D	124	24	70	100	10	10000
80121B	TACU001KM40DA60648393	40	001	ER	D	124	24	70	100	10	10000
80121S	TACU001KM40DA60648393	40	001	ER	D	124	24	70	100	10	10000

TACU001KM40DA60648393

TACU

Turret Adapted Clamping Unit

001

Machine Mount Code (MMC)

KM

System Style

KM = KM
ER = ER

40

System Size (CSWS)

25, 32, 40, 50, 63

D

Tool Type

S = Static Tool
D = Driven Tool

A

Tool Orientation

A = Axial
R = Radial

60648393

8 Digit Drawing Number

DOOSAN™ • STATIC TOOL AXIAL • KM™ • MMC 035

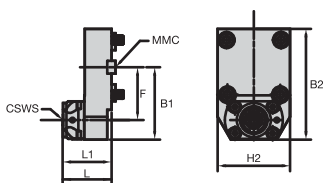
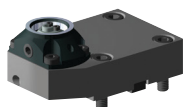

order number	catalogue number	CSWS	MMC	B1	B2	F	H2	L	L1	cp		CF
6391657	TACU035KM40SA60945565	KM40	035	85	130	62,0	85	57	57,0	Bar	PSI	i

DOOSAN • STATIC TOOL RADIAL • KM • MMC 035

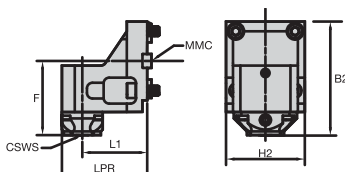

order number	catalogue number	CSWS	MMC	B2	F	H2	L1	LPR	cp		CF
6391658	TACU035KM40SR60945566	KM40	035	123	80,0	85	70,0	92	Bar	PSI	i

DOOSAN • DRIVEN TOOL AXIAL • KM • MMC 035

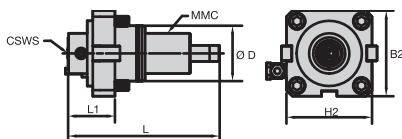

order number	catalogue number	CSWS	MMC	B2	D	H2	L	L1	mST (Nm)	cp		CF	CS1	max RPM
6391653	TACU035KM32DA60945561	KM32	035	85	55	85	151	46,5	25	Bar	PSI	i/e	G 1/8	6000
6391654	TACU035KM32DA60945562	KM32	035	85	55	85	151	46,5	25	100	1500	e	G 1/8	6000

DOOSAN • DRIVEN TOOL AXIAL • ER™ • MMC 035

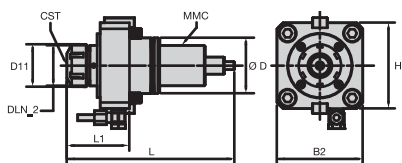
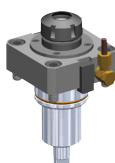

order number	catalogue number	CST	MMC	B2	D	D11	DLN 2	H2	L	L1	mST (Nm)	cp		CF	CS1	max RPM
6588989	TACU035ER25DA61301859	ER25	035	85	55	42	63	85	166	60,5	25	Bar	PSI	i/e	G 1/8	6000

76	29	4	65

DOOSAN™ • DRIVEN TOOL RADIAL • KM™ • MMC 035

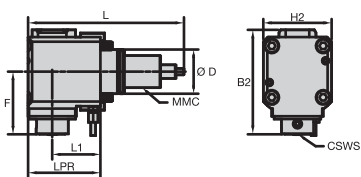
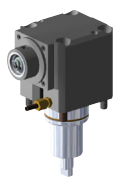

order number	catalogue number	CSWS	MMC	B2	D	F	H2	L	L1	LPR	mST (Nm)	cp			CS1	max RPM
												Bar	PSI	CF		
6391655	TACU035KM32DR60945563	KM32	035	130	55	78,0	85	194	60,0	90	25	100	1500	e	G 1/8	6000
6391656	TACU035KM32DR60945564	KM32	035	149	55	78,0	85	194	60,0	90	25	70	1000	i/e	G 1/8	6000

DOOSAN • DRIVEN TOOL RADIAL • ER™ • MMC 035

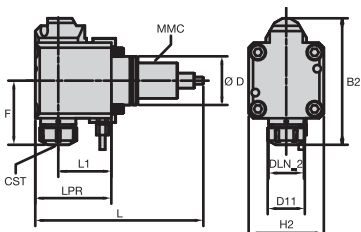

order number	catalogue number	CST	MMC	B2	D	D11	DLN 2	F	H2	L	L1	LPR	mST (Nm)	cp			CS1	max RPM
														Bar	PSI	CF		
6588990	TACU035ER25DR61301860	ER25	035	142	55	42	40	71,0	85	190	60,0	86	25	70	1000	i/e	G 1/8	6000

DOOSAN • STATIC TOOL AXIAL • KM • MMC 036

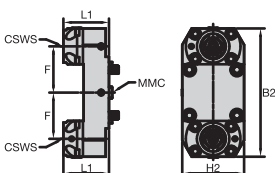
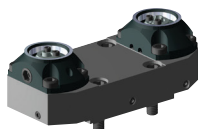

order number	catalogue number	CSWS	MMC	B2	F	H2	L1	cp		
								Bar	PSI	CF
6391609	TACU036KM50SA60945571 *	KM50	036	197	71,0	95	70,0	100	1500	i

DOOSAN • STATIC TOOL AXIAL • KM • MMC 036

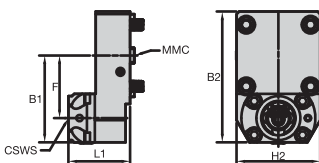
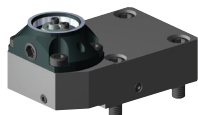

order number	catalogue number	CSWS	MMC	B1	B2	F	H2	L1	cp		
									Bar	PSI	CF
6391651	TACU036KM50SA60945573	KM50	036	99	149	71,0	95	70,0	100	1500	i



NOTE: * = Only usable on machines equipped with sub-spindle.

DOOSAN™ • STATIC TOOL RADIAL • KM™ • MMC 036

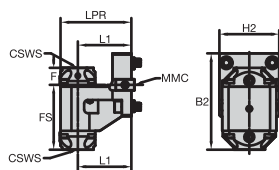

order number	catalogue number	CSWS	MMC	B2	F	FS	H2	L1	LPR	cp			
6391610	TACU036KM50SR60945572 *	KM50	036	153	27,0	103,0	95	85,0	113	Bar	PSI	CF	i

DOOSAN • STATIC TOOL RADIAL • KM • MMC 036

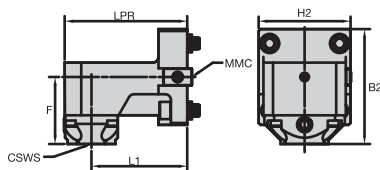

order number	catalogue number	CSWS	MMC	B2	F	H2	L1	LPR	cp			
6391652	TACU036KM50SR60945574	KM50	036	120	70,0	96	100,0	128	Bar	PSI	CF	i

DOOSAN • DRIVEN TOOL AXIAL • KM • MMC 036

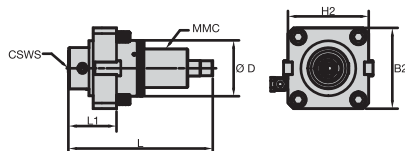
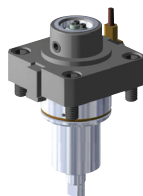

order number	catalogue number	CSWS	MMC	B2	D	H2	L	L1	mST (Nm)	cp			CF	CS1	max RPM
6391605	TACU036KM40DA60945567	KM40	036	94	65	94	168	56,0	50	Bar	PSI	e	G 1/8	6000	
6391606	TACU036KM40DA60945568	KM40	036	94	65	94	168	56,0	50	25	360	i/e	G 1/8	6000	

DOOSAN • DRIVEN TOOL AXIAL • ER™ • MMC 036

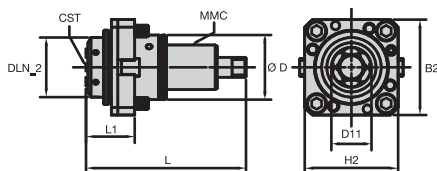

order number	catalogue number	CST	MMC	B2	D	D11	DLN_2	H2	L	L1	mST (Nm)	cp			CF	CS1	max RPM
6589001	TACU036ER32DA61301861	ER32	036	96	65	39	60	94	161	47,0	50	Bar	PSI	i/e	M10X1	5000	



NOTE: * = Only usable on machines equipped with sub-spindle.

DOOSAN™ • DRIVEN TOOL RADIAL • KM™ • MMC 036

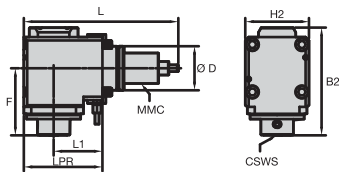
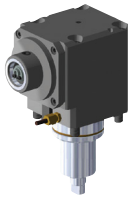

order number	catalogue number	CSWS	MMC	B2	D	F	H2	L	L1	LPR	cp				max RPM	
											mST (Nm)	Bar	PSI	CF		CS1
6391607	TACU036KM4DR60945569	KM40	036	159	65	99,0	94	228	72,0	116	50	100	1500	e	G 1/8	6000
6391608	TACU036KM4DR60945570	KM40	036	178	65	99,0	94	228	72,0	116	50	70	1000	i/e	G 1/8	6000

DOOSAN • DRIVEN TOOL RADIAL • ER™ • MMC 036

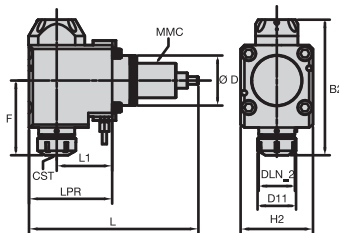
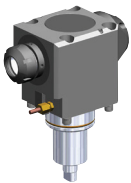

order number	catalogue number	CST	MMC	B2	D	D11	DLN_2	F	H2	L	L1	LPR	cp				max RPM	
													mST (Nm)	Bar	PSI	CF		CS1
6589002	TACU036ER32DR61301862	ER32	036	174	65	50	47	94,5	94	221	72,0	109	50	70	1000	i/e	G 1/8	6000



HAAS™ • STATIC TOOL RADIAL • KM™ • MMC 013

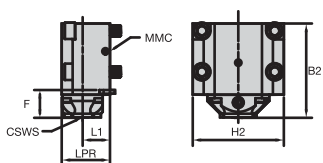

order number	catalogue number	CSWS	MMC	B2	F	H2	L1	LPR	cp		
									Bar	PSI	CF
6391732	TACU013KM40SR60907381	KM40	013	103	30,0	100	30,0	53	100	1500	i
6391733	TACU013KM50SR60907382	KM50	013	108	35,0	100	40,0	69	100	1500	i

HAAS • STATIC TOOL AXIAL • KM • MMC 036

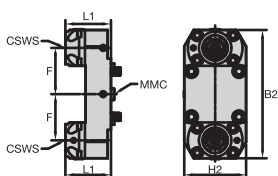
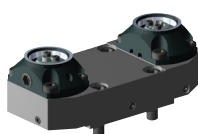

order number	catalogue number	CSWS	MMC	B2	F	H2	L1	cp		
								Bar	PSI	CF
6391609	TACU036KM50SA60945571 *	KM50	036	197	71,0	95	70,0	100	1500	i

HAAS • STATIC TOOL AXIAL • KM • MMC 036

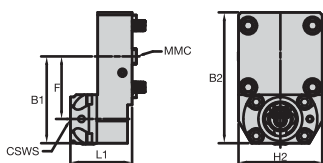
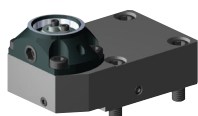

order number	catalogue number	CSWS	MMC	B1	B2	F	H2	L1	cp		
									Bar	PSI	CF
6391651	TACU036KM50SA60945573	KM50	036	99	149	71,0	95	70,0	100	1500	i

HAAS • STATIC TOOL RADIAL • KM • MMC 036

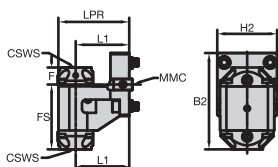

order number	catalogue number	CSWS	MMC	B2	F	FS	H2	L1	LPR	cp		
										Bar	PSI	CF
6391610	TACU036KM50SR60945572 *	KM50	036	153	27,0	103,0	95	85,0	113	100	1500	i



NOTE: * = Only usable on machines equipped with sub-spindle.

HAAS™ • STATIC TOOL RADIAL • KM™ • MMC 036

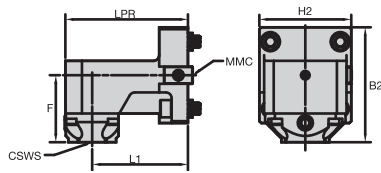

order number	catalogue number	CSWS	MMC	B2	F	H2	L1	LPR	Bar	PSI	CF
6391652	TACU036KM50SR60945574	KM50	036	120	70,0	96	100,0	128	100	1500	i

HAAS • DRIVEN TOOL AXIAL • KM • MMC 036

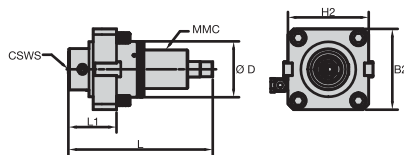
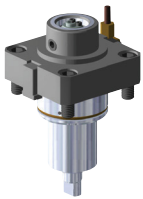

order number	catalogue number	CSWS	MMC	B2	D	H2	L	L1	mST (Nm)	Bar	PSI	CF	CS1	max RPM
6391605	TACU036KM40DA60945567	KM40	036	94	65	94	168	56,0	50	100	1500	e	G 1/8	6000
6391606	TACU036KM40DA60945568	KM40	036	94	65	94	168	56,0	50	25	360	i/e	G 1/8	6000

HAAS • DRIVEN TOOL AXIAL • ER™ • MMC 036

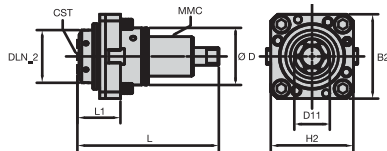
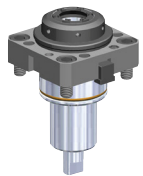

order number	catalogue number	CST	MMC	B2	D	D11	DLN_2	H2	L	L1	mST (Nm)	Bar	PSI	CF	CS1	max RPM
6589001	TACU036ER32DA61301861	ER32	036	96	65	39	60	94	161	47,0	50	70	1000	i/e	M10X1	5000

HAAS • DRIVEN TOOL RADIAL • KM • MMC 036

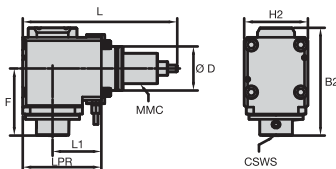
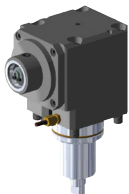

order number	catalogue number	CSWS	MMC	B2	D	F	H2	L	L1	LPR	mST (Nm)	Bar	PSI	CF	CS1	max RPM
6391607	TACU036KM40DR60945569	KM40	036	159	65	99,0	94	228	72,0	116	50	100	1500	e	G 1/8	6000
6391608	TACU036KM40DR60945570	KM40	036	178	65	99,0	94	228	72,0	116	50	70	1000	i/e	G 1/8	6000



HAAS™ • DRIVEN TOOL RADIAL • ER™ • MMC 036

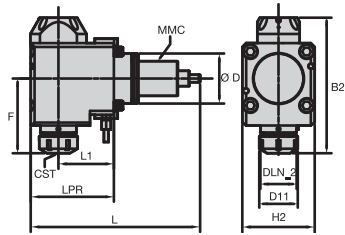
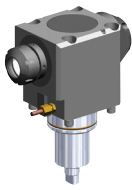

order number	catalogue number	CST	MMC	B2	D	D11	DLN_2	F	H2	L	L1	LPR	mST (Nm)	cp			CF	CS1	max RPM
6589002	TACU036ER32DR61301862	ER32	036	174	65	50	47	94,5	94	221	72,0	109	50	70	1000	i/e	G 1/8	6000	

76	29	4	65

HWACHEON™ • STATIC TOOL AXIAL • KM™ • MMC 035

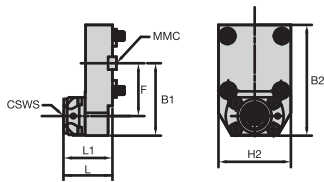

order number	catalogue number	CSWS	MMC	B1	B2	F	H2	L	L1	cp		CF
6391657	TACU035KM40SA60945565	KM40	035	85	130	62,0	85	57	57,0	Bar	PSI	i

HWACHEON • STATIC TOOL RADIAL • KM • MMC 035

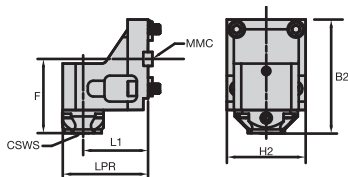

order number	catalogue number	CSWS	MMC	B2	F	H2	L1	LPR	cp		CF
6391658	TACU035KM40SR60945566	KM40	035	123	80,0	85	70,0	92	Bar	PSI	i

HWACHEON • DRIVEN TOOL AXIAL • KM • MMC 035

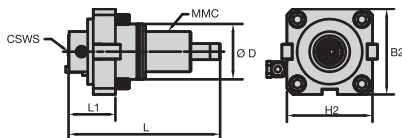

order number	catalogue number	CSWS	MMC	B2	D	H2	L	L1	mST (Nm)	cp		CF	CS1	max RPM
6391653	TACU035KM32DA60945561	KM32	035	85	55	85	151	46,5	25	25	360	i/e	G 1/8	6000
6391654	TACU035KM32DA60945562	KM32	035	85	55	85	151	46,5	25	100	1500	e	G 1/8	6000

HWACHEON • DRIVEN TOOL AXIAL • ER™ • MMC 035

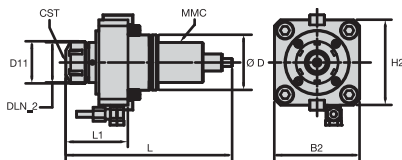
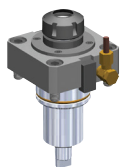

order number	catalogue number	CST	MMC	B2	D	D11	DLN_2	H2	L	L1	mST (Nm)	cp		CF	CS1	max RPM
6588989	TACU035ER25DA61301859	ER25	035	85	55	42	63	85	166	60,5	25	25	360	i/e	G 1/8	6000



HWACHEON™ • DRIVEN TOOL RADIAL • KM™ • MMC 035

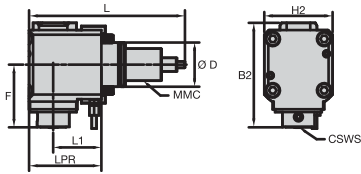
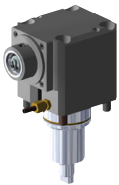

order number	catalogue number	CSWS	MMC	B2	D	F	H2	L	L1	LPR	mST (Nm)	cp Bar	PSI	CF	CS1	max RPM
6391655	TACU035KM32DR60945563	KM32	035	130	55	78,0	85	194	60,0	90	25	100	1500	e	G 1/8	6000
6391656	TACU035KM32DR60945564	KM32	035	149	55	78,0	85	194	60,0	90	25	70	1000	i/e	G 1/8	6000

HWACHEON • DRIVEN TOOL RADIAL • ER™ • MMC 035

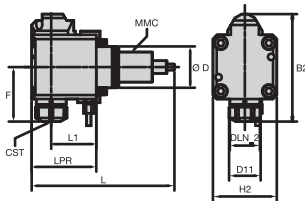
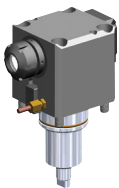

order number	catalogue number	CST	MMC	B2	D	D11	DLN 2	F	H2	L	L1	LPR	mST (Nm)	cp Bar	PSI	CF	CS1	max RPM
6588990	TACU035ER25DR61301860	ER25	035	142	55	42	40	71,0	85	190	60,0	86	25	70	1000	i/e	G 1/8	6000

HWACHEON • STATIC TOOL AXIAL • KM • MMC 036

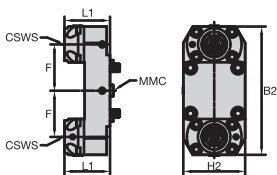
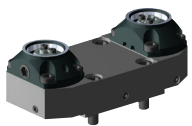

order number	catalogue number	CSWS	MMC	B2	F	H2	L1	cp Bar	PSI	CF
6391609	TACU036KM50SA60945571 *	KM50	036	197	71,0	95	70,0	100	1500	i

HWACHEON • STATIC TOOL AXIAL • KM • MMC 036

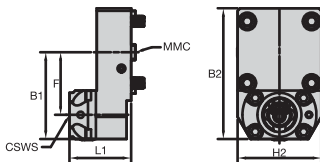

order number	catalogue number	CSWS	MMC	B1	B2	F	H2	L1	cp Bar	PSI	CF
6391651	TACU036KM50SA60945573	KM50	036	99	149	71,0	95	70,0	100	1500	i



NOTE: * = Only usable on machines equipped with sub-spindle.

HWACHEON™ • STATIC TOOL RADIAL • KM™ • MMC 036

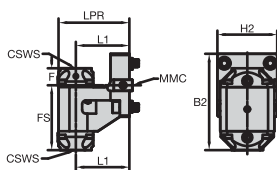

order number	catalogue number	CSWS	MMC	B2	F	FS	H2	L1	LPR	Bar	cp	PSI	CF
6391610	TACU036KM50SR60945572 *	KM50	036	153	27,0	103,0	95	85,0	113	100		1500	i

HWACHEON • STATIC TOOL RADIAL • KM • MMC 036

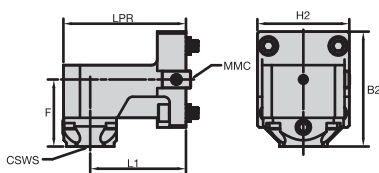

order number	catalogue number	CSWS	MMC	B2	F	H2	L1	LPR	Bar	cp	PSI	CF
6391652	TACU036KM50SR60945574	KM50	036	120	70,0	96	100,0	128	100		1500	i

HWACHEON • DRIVEN TOOL AXIAL • KM • MMC 036

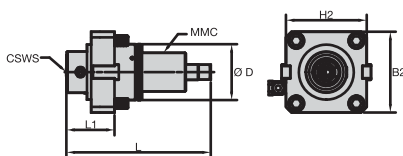
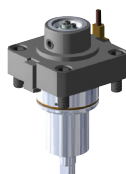

order number	catalogue number	CSWS	MMC	B2	D	H2	L	L1	mST (Nm)	Bar	cp	PSI	CF	CS1	max RPM
6391605	TACU036KM40DA60945567	KM40	036	94	65	94	168	56,0	50	100		1500	e	G 1/8	6000
6391606	TACU036KM40DA60945568	KM40	036	94	65	94	168	56,0	50	25		360	i/e	G 1/8	6000

HWACHEON • DRIVEN TOOL AXIAL • ER™ • MMC 036

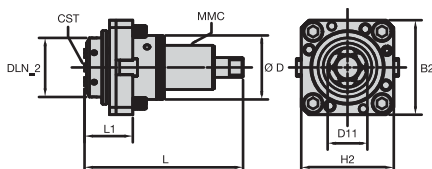

order number	catalogue number	CST	MMC	B2	D	D11	DLN_2	H2	L	L1	mST (Nm)	Bar	cp	PSI	CF	CS1	max RPM
6589001	TACU036ER32DA61301861	ER32	036	96	65	39	60	94	161	47,0	50	70		1000	i/e	M10X1	5000



NOTE: * = Only usable on machines equipped with sub-spindle.

HWACHEON™ • DRIVEN TOOL RADIAL • KM™ • MMC 036

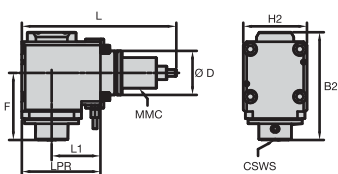

order number	catalogue number	CSWS	MMC	B2	D	F	H2	L	L1	LPR	mST (Nm)	cp Bar	cp PSI	CF	CS1	max RPM
6391607	TACU036KM40DR60945569	KM40	036	159	65	99,0	94	228	72,0	116	50	100	1500	e	G 1/8	6000
6391608	TACU036KM40DR60945570	KM40	036	178	65	99,0	94	228	72,0	116	50	70	1000	i/e	G 1/8	6000

HWACHEON • DRIVEN TOOL RADIAL • ER™ • MMC 036

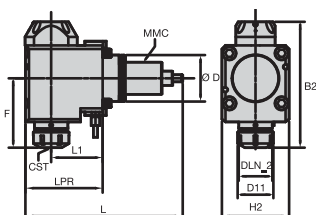
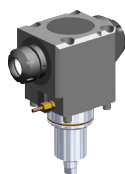

order number	catalogue number	CST	MMC	B2	D	D11	DLN_2	F	H2	L	L1	LPR	mST (Nm)	cp Bar	cp PSI	CF	CS1	max RPM
6589002	TACU036ER32DR61301862	ER32	036	174	65	50	47	94,5	94	221	72,0	109	50	70	1000	i/e	G 1/8	6000

76	29	4	65

HYUNDAI WIA • STATIC TOOL AXIAL • KM™ • MMC 035

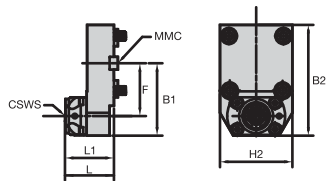

order number	catalogue number	CSWS	MMC	B1	B2	F	H2	L	L1	Bar	cp	PSI	CF
6391657	TACU035KM40SA60945565	KM40	035	85	130	62,0	85	57	57,0	100		1500	i

HYUNDAI WIA • STATIC TOOL RADIAL • KM • MMC 035

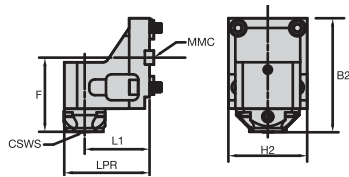

order number	catalogue number	CSWS	MMC	B2	F	H2	L1	LPR	Bar	cp	PSI	CF
6391658	TACU035KM40SR60945566	KM40	035	123	80,0	85	70,0	92	100		1500	i

HYUNDAI WIA • DRIVEN TOOL AXIAL • KM • MMC 035

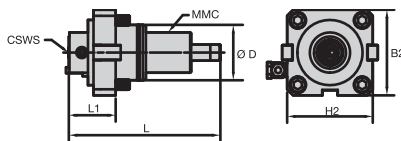
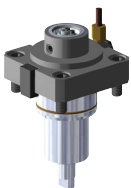

order number	catalogue number	CSWS	MMC	B2	D	H2	L	L1	mST (Nm)	Bar	cp	PSI	CF	CS1	max RPM
6391653	TACU035KM32DA60945561	KM32	035	85	55	85	151	46,5	25	25		360	i/e	G 1/8	6000
6391654	TACU035KM32DA60945562	KM32	035	85	55	85	151	46,5	25	100		1500	e	G 1/8	6000

HYUNDAI WIA • DRIVEN TOOL AXIAL • ER™ • MMC 035

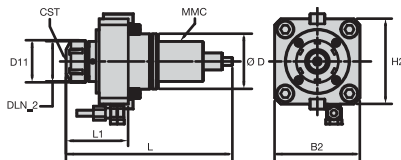
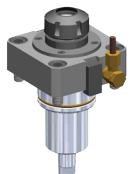

order number	catalogue number	CST	MMC	B2	D	D11	DLN 2	H2	L	L1	mST (Nm)	Bar	cp	PSI	CF	CS1	max RPM
6588989	TACU035ER25DA61301859	ER25	035	85	55	42	63	85	166	60,5	25	25		360	i/e	G 1/8	6000



HYUNDAI WIA • DRIVEN TOOL RADIAL • KM™ • MMC 035

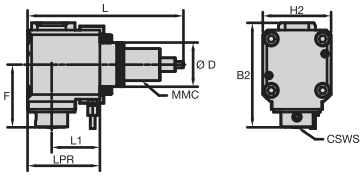
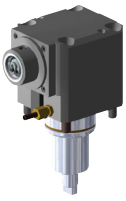

order number	catalogue number	CSWS	MMC	B2	D	F	H2	L	L1	LPR	mST (Nm)	cp Bar	PSI	CF	CS1	max RPM
6391655	TACU035KM32DR60945563	KM32	035	130	55	78,0	85	194	60,0	90	25	100	1500	e	G 1/8	6000
6391656	TACU035KM32DR60945564	KM32	035	149	55	78,0	85	194	60,0	90	25	70	1000	i/e	G 1/8	6000

HYUNDAI WIA • DRIVEN TOOL RADIAL • ER™ • MMC 035

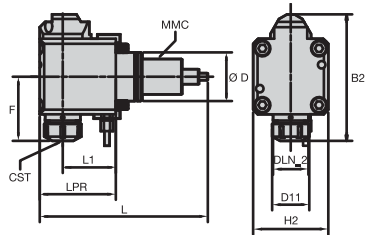
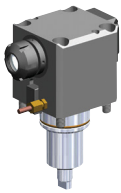

order number	catalogue number	CST	MMC	B2	D	D11	DLN 2	F	H2	L	L1	LPR	mST (Nm)	cp Bar	PSI	CF	CS1	max RPM
6588990	TACU035ER25DR61301860	ER25	035	142	55	42	40	71,0	85	190	60,0	86	25	70	1000	i/e	G 1/8	6000

HYUNDAI WIA • STATIC TOOL AXIAL • KM • MMC 036

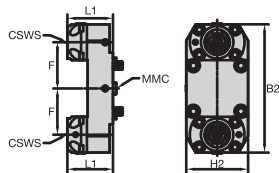

order number	catalogue number	CSWS	MMC	B2	F	H2	L1	Bar	cp PSI	CF
6391609	TACU036KM50SA60945571 *	KM50	036	197	71,0	95	70,0	100	1500	i

HYUNDAI WIA • STATIC TOOL AXIAL • KM • MMC 036

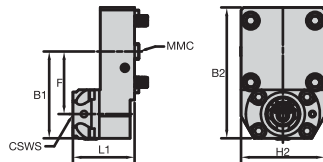

order number	catalogue number	CSWS	MMC	B1	B2	F	H2	L1	Bar	cp PSI	CF
6391651	TACU036KM50SA60945573	KM50	036	99	149	71,0	95	70,0	100	1500	i



NOTE: * = Only usable on machines equipped with sub-spindle.

HYUNDAI WIA • STATIC TOOL RADIAL • KM™ • MMC 036

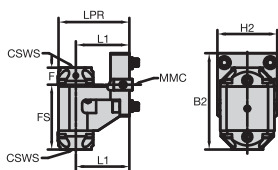

order number	catalogue number	CSWS	MMC	B2	F	FS	H2	L1	LPR	Bar	cp	PSI	CF
6391610	TACU036KM50SR60945572 *	KM50	036	153	27,0	103,0	95	85,0	113	100		1500	i

HYUNDAI WIA • STATIC TOOL RADIAL • KM • MMC 036

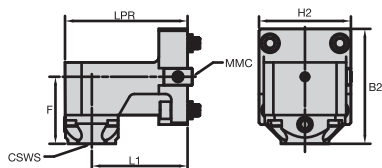

order number	catalogue number	CSWS	MMC	B2	F	H2	L1	LPR	Bar	cp	PSI	CF
6391652	TACU036KM50SR60945574	KM50	036	120	70,0	96	100,0	128	100		1500	i

HYUNDAI WIA • DRIVEN TOOL AXIAL • KM • MMC 036

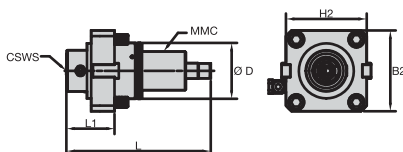

order number	catalogue number	CSWS	MMC	B2	D	H2	L	L1	mST (Nm)	Bar	cp	PSI	CF	CS1	max RPM
6391605	TACU036KM40DA60945567	KM40	036	94	65	94	168	56,0	50	100		1500	e	G 1/8	6000
6391606	TACU036KM40DA60945568	KM40	036	94	65	94	168	56,0	50	25		360	i/e	G 1/8	6000

HYUNDAI WIA • DRIVEN TOOL AXIAL • ER™ • MMC 036

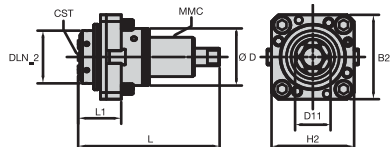
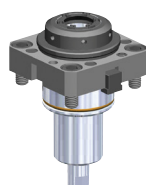

order number	catalogue number	CST	MMC	B2	D	D11	DLN_2	H2	L	L1	mST (Nm)	Bar	cp	PSI	CF	CS1	max RPM
6589001	TACU036ER32DA61301861	ER32	036	96	65	39	60	94	161	47,0	50	70		1000	i/e	M10X1	5000



NOTE: * = Only usable on machines equipped with sub-spindle.

HYUNDAI WIA • DRIVEN TOOL RADIAL • KM™ • MMC 036

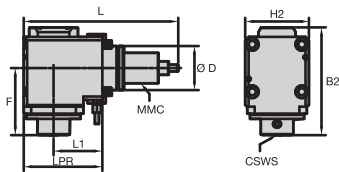

order number	catalogue number	CSWS	MMC	B2	D	F	H2	L	L1	LPR	cp					max RPM
											mST (Nm)	Bar	PSI	CF	CS1	
6391607	TACU036KM40DR60945569	KM40	036	159	65	99,0	94	228	72,0	116	50	100	1500	e	G 1/8	6000
6391608	TACU036KM40DR60945570	KM40	036	178	65	99,0	94	228	72,0	116	50	70	1000	i/e	G 1/8	6000

HYUNDAI WIA • DRIVEN TOOL RADIAL • ER™ • MMC 036

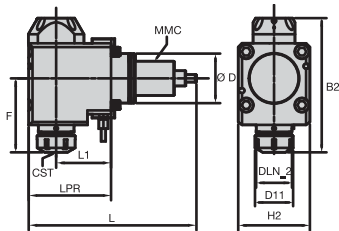
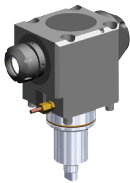

order number	catalogue number	CST	MMC	B2	D	D11	DLN_2	F	H2	L	L1	LPR	cp					max RPM
													mST (Nm)	Bar	PSI	CF	CS1	
6589002	TACU036ER32DR61301862	ER32	036	174	65	50	47	94,5	94	221	72,0	109	50	70	1000	i/e	G 1/8	6000

76	29	4	65

MAZAK™ • STATIC TOOL AXIAL • KM™ • MMC 016

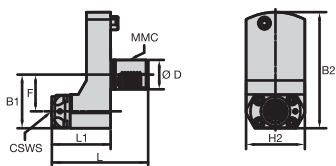
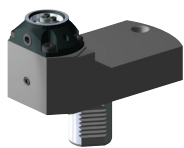

order number	catalogue number	CSWS	MMC	B1	B2	D	F	H2	L	L1	Bar	cp	PSI	CF
6401906	TACU016KM40SA60908132	KM40	016	73	158	40	50,0	80	131	80,0	100		1500	i

MAZAK • STATIC TOOL AXIAL • KM • MMC 016

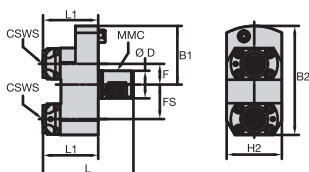

order number	catalogue number	CSWS	MMC	B1	B2	D	F	FS	H2	L	L1	Bar	cp	PSI	CF
6401907	TACU016KM40SA60908134 *	KM40	016	85	158	40	30,0	50,0	80	131	80,0	100		1500	i

MAZAK • STATIC TOOL RADIAL • KM • MMC 016

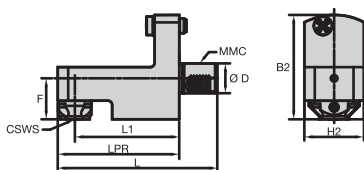

order number	catalogue number	CSWS	MMC	B2	D	F	H2	L	L1	LPR	Bar	cp	PSI	CF
6401908	TACU016KM40SR60908135	KM40	016	140	40	55,0	80	214	140,0	163	100		1500	i

MAZAK • STATIC TOOL RADIAL • KM • MMC 016

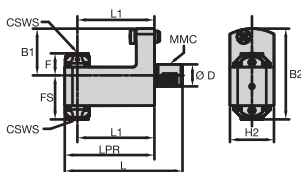

order number	catalogue number	CSWS	MMC	B1	B2	D	F	FS	H2	L	L1	LPR	Bar	cp	PSI	CF
6401909	TACU016KM40SR60908136 *	KM40	016	85	165	40	40,0	80,0	80	214	140,0	163	100		1500	i

76	29	4	65

NOTE: * = Only usable on machines equipped with sub-spindle.

MAZAK™ • DRIVEN TOOL AXIAL • KM™ • MMC 016

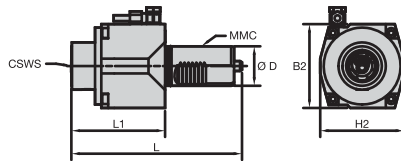

order number	catalogue number	CSWS	MMC	B2	D	H2	L	L1	mST (Nm)	cp		CF	CS1	max RPM
6401890	TACU016KM40DA60908100	KM40	016	85	40	85	173	95,0	50	100	1500	e	G 1/8	6000
6401901	TACU016KM40DA60908102	KM40	016	85	40	85	173	95,0	50	25	360	i/e	G 1/8	6000

MAZAK • DRIVEN TOOL AXIAL • KM • MMC 016

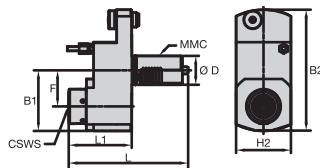
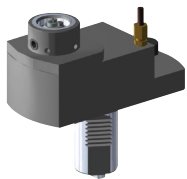

order number	catalogue number	CSWS	MMC	B1	B2	D	F	H2	L	L1	mST (Nm)	cp		CF	CS1	max RPM
6401902	TACU016KM40DA60908120	KM40	016	84	168	40	50,0	76	166	87,5	50	100	1500	e	G 1/8	6000
6401903	TACU016KM40DA60908125	KM40	016	84	168	40	50,0	78	191	112,5	50	70	1000	i/e	G 1/8	6000

MAZAK • DRIVEN TOOL AXIAL • ER™ • MMC 016

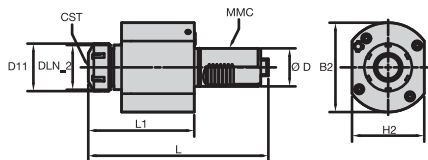

order number	catalogue number	CST	MMC	B2	D	D11	DLN_2	H2	L	L1	mST (Nm)	cp		CF	CS1	max RPM
6588967	TACU016ER32DA61301847	ER32	016	94	40	50	47	76	190	109,0	50	25	360	i/e	M12X1	6000

MAZAK • DRIVEN TOOL AXIAL • ER • MMC 016

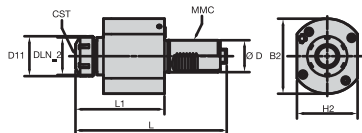
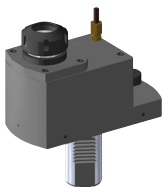

order number	catalogue number	CST	MMC	B1	B2	D	D11	DLN_2	F	H2	L	L1	mST (Nm)	cp		CF	CS1	max RPM
6588968	TACU016ER32DA61301848	ER32	016	84	168	40	50	47	50,0	78	200	118,5	50	70	1000	i/e	G 1/8	6000



MAZAK™ • DRIVEN TOOL RADIAL • KM™ • MMC 016

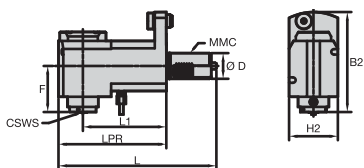
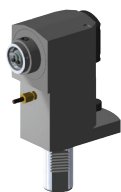

order number	catalogue number	CSWS	MMC	B2	D	F	H2	L	L1	LPR	mST (Nm)	cp			max RPM	
6401904	TACU016KM40DR60908103	KM40	016	157	40	72,5	76	246	130,0	168	50	100	1500	e	G 1/8	6000
6401905	TACU016KM40DR60908107	KM40	016	157	40	72,5	76	246	130,0	168	50	70	1000	i/e	G 1/8	6000

MAZAK • DRIVEN TOOL RADIAL • ER™ • MMC 016

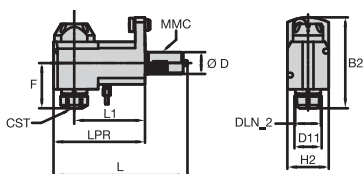
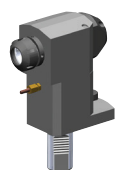

order number	catalogue number	CST	MMC	B2	D	D11	DLN_2	F	H2	L	L1	LPR	mST (Nm)	cp			max RPM	
6588969	TACU016ER32DR61301849	ER32	016	165	40	50	47	80,5	76	246	130,0	168	50	70	1000	i/e	G 1/8	6000

MAZAK • STATIC TOOL AXIAL • KM • MMC 017

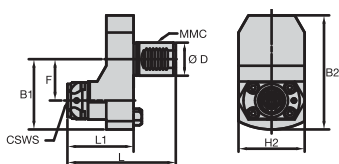
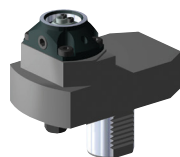

order number	catalogue number	CSWS	MMC	B1	B2	D	F	H2	L	L1	Bar	cp		CF
6391714	TACU017KM40SA60908159	KM40	017	85	138	40	50,0	80	131	80,0	100	1500		i

MAZAK • STATIC TOOL AXIAL • KM • MMC 017

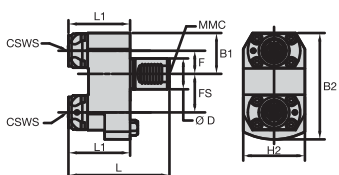

order number	catalogue number	CSWS	MMC	B1	B2	D	F	FS	H2	L	L1	Bar	cp		CF
6391715	TACU017KM40SA60908160 *	KM40	017	53	138	40	30,0	50,0	80	131	80,0	100	1500		i



NOTE: * = Only usable on machines equipped with sub-spindle.

MAZAK™ • STATIC TOOL RADIAL • KM™ • MMC 017

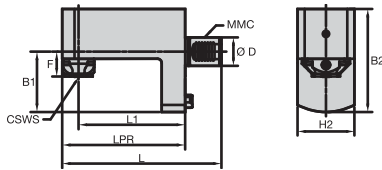

order number	catalogue number	CSWS	MMC	B1	B2	D	F	H2	L	L1	LPR	cp			CF
6391716	TACU017KM40SR60908161	KM40	017	85	145	40	35,0	80	224	150,0	173	Bar	PSI	CF	
												100	1500	i	

MAZAK • STATIC TOOL RADIAL • KM • MMC 017

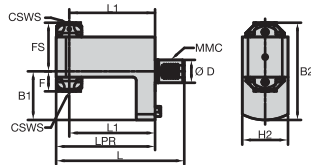

order number	catalogue number	CSWS	MMC	B1	B2	D	F	FS	H2	L	L1	LPR	cp			CF
6391717	TACU017KM40SR60908162 *	KM40	017	85	170	40	35,0	85,0	80	224	150,0	173	Bar	PSI	CF	
													100	1500	i	

MAZAK • DRIVEN TOOL AXIAL • KM • MMC 017

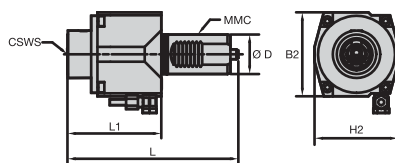
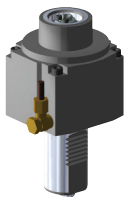

order number	catalogue number	CSWS	MMC	B2	D	H2	L	L1	mST (Nm)	cp			CF	CS1	max RPM
6391698	TACU017KM40DA60908150	KM40	017	85	40	85	173	95,0	50	Bar	PSI	CF	CS1	max RPM	
6391699	TACU017KM40DA60908151	KM40	017	85	40	85	173	95,0	50	25	360	i/e	G 1/8	6000	

MAZAK • DRIVEN TOOL AXIAL • KM • MMC 017

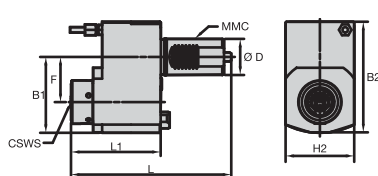
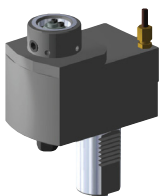

order number	catalogue number	CSWS	MMC	B1	B2	D	F	H2	L	L1	mST (Nm)	cp			CF	CS1	max RPM
6391700	TACU017KM40DA60908155	KM40	017	84	123	40	50,0	76	178	99,5	50	Bar	PSI	CF	CS1	max RPM	
6391711	TACU017KM40DA60908156	KM40	017	84	123	40	50,0	78	191	112,5	50	70	1000	i/e	G 1/8	6000	



NOTE: * = Only usable on machines equipped with sub-spindle.

MAZAK™ • DRIVEN TOOL AXIAL • ER™ • MMC 017

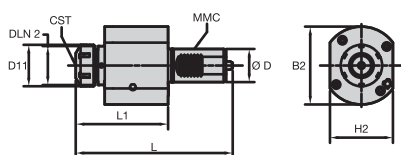

order number	catalogue number	CST	MMC	B2	D	D11	DLN_2	H2	L	L1	mST (Nm)	cp Bar	PSI	CF	CS1	max RPM
6588970	TACU017ER32DA61301850	ER32	017	94	40	50	47	76	190	109,0	50	25	360	i/e	M12X1	6000

MAZAK • DRIVEN TOOL AXIAL • ER • MMC 017

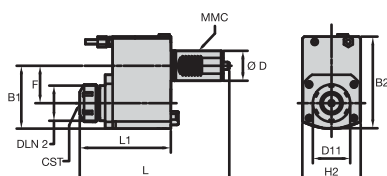

order number	catalogue number	CST	MMC	B1	B2	D	D11	DLN_2	F	H2	L	L1	mST (Nm)	cp Bar	PSI	CF	CS1	max RPM
6588981	TACU017ER32DA61301851	ER32	017	84	123	40	50	47	50,0	78	200	119,5	50	70	1000	i/e	G 1/8	6000

MAZAK • DRIVEN TOOL RADIAL • KM™ • MMC 017

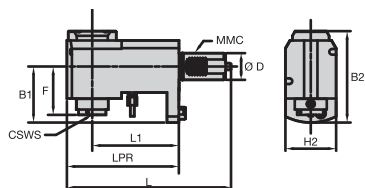
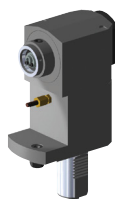

order number	catalogue number	CSWS	MMC	B1	B2	D	F	H2	L	L1	LPR	mST (Nm)	cp Bar	PSI	CF	CS1	max RPM
6391712	TACU017KM40DR60908157	KM40	017	84	137	40	72,5	76	246	130,0	168	50	100	1500	e	G 1/8	6000
6391713	TACU017KM40DR60908158	KM40	017	84	156	40	72,5	76	246	130,0	168	50	70	1000	i/e	G 1/8	6000

MAZAK • DRIVEN TOOL RADIAL • ER • MMC 017

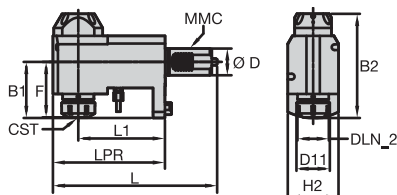
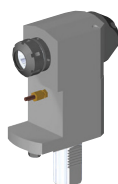

order number	catalogue number	CST	MMC	B1	B2	D	D11	DLN_2	F	H2	L	L1	LPR	mST (Nm)	cp Bar	PSI	CF	CS1	max RPM
6588982	TACU017ER32DR61301852	ER32	017	84	156	40	50	47	80,5	76	246	130,0	168	50	70	1000	i/e	G 1/8	6000



MAZAK™ • STATIC TOOL AXIAL • KM™ • MMC 018

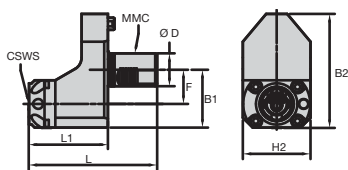

order number	catalogue number	CSWS	MMC	B1	B2	D	F	H2	L	L1	Bar	cp	PSI	CF
6391696	TACU018KM63SA60908174	KM63	018	88	173	50	52,0	103	195	120,0	100		1500	i

MAZAK • STATIC TOOL RADIAL • KM • MMC 018

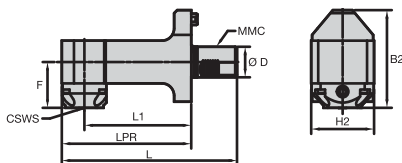

order number	catalogue number	CSWS	MMC	B2	D	F	H2	L	L1	LPR	Bar	cp	PSI	CF
6391697	TACU018KM63SR60908176	KM63	018	160	50	75,0	103	287	175,0	212	100		1500	i

MAZAK • DRIVEN TOOL AXIAL • KM • MMC 018

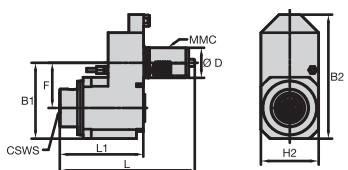
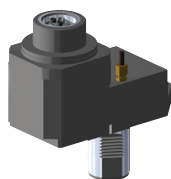

order number	catalogue number	CSWS	MMC	B1	B2	D	F	H2	L	L1	mST (Nm)	Bar	cp	PSI	CF	CS1	max RPM
6391692	TACU018KM50DA60908166	KM50	018	126	206	50	75,0	96	225	139,5	100	100		1500	e	G 1/8	6000
6391693	TACU018KM50DA60908171	KM50	018	126	206	50	75,0	96	225	139,5	100	70		1000	i/e	G 1/8	6000

MAZAK • DRIVEN TOOL AXIAL • ER™ • MMC 018

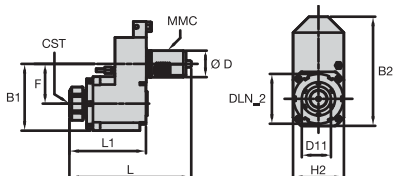
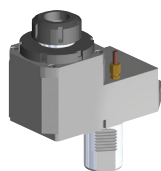

order number	catalogue number	CST	MMC	B1	B2	D	D11	DLN_2	F	H2	L	L1	mST (Nm)	Bar	cp	PSI	CF	CS1	max RPM
6588983	TACU018ER40DA61301853	ER40	018	126	206	50	63	94	75,0	96	230	141,5	100	70		1000	i/e	G 1/8	6000

76	29	4	65

MAZAK™ • DRIVEN TOOL RADIAL • KM™ • MMC 018

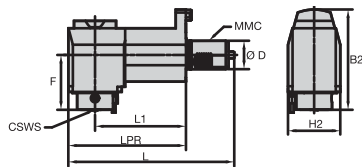

order number	catalogue number	CSWS	MMC	B2	D	F	H2	L	L1	LPR	mST (Nm)	Bar	cp PSI	CF	CS1	max RPM
6391694	TACU018KM50DR60908172	KM50	018	177	50	96,5	92	292	160,0	207	100	100	1500	e	G 1/8	6000
6391695	TACU018KM50DR60908173	KM50	018	177	50	96,5	92	292	160,0	207	100	70	1000	i/e	G 1/8	6000

MAZAK • DRIVEN TOOL RADIAL • ER™ • MMC 018

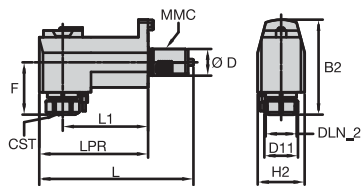

order number	catalogue number	CST	MMC	B2	D	D11	DLN_2	F	H2	L	L1	LPR	mST (Nm)	Bar	cp PSI	CF	CS1	max RPM
6588984	TACU018ER40DR61301854	ER40	018	175	50	63	58	94,5	88	289	160,0	204	100	70	1000	i/e	G 1/8	6000

MAZAK • STATIC TOOL AXIAL • KM • MMC 019

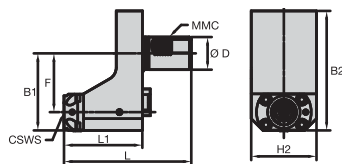
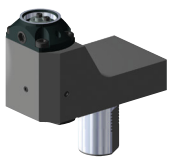

order number	catalogue number	CSWS	MMC	B1	B2	D	F	H2	L	L1	Bar	cp PSI	CF
6391679	TACU019KM50SA60945552	KM50	019	118	183	50	90,0	100	195	120,0	100	1500	i

MAZAK • STATIC TOOL AXIAL • KM • MMC 019

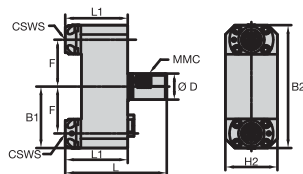

order number	catalogue number	CSWS	MMC	B1	B2	D	F	H2	L	L1	Bar	cp PSI	CF
6391680	TACU019KM50SA60945553 *	KM50	019	118	236	50	90,0	100	195	120,0	100	1500	i



NOTE: * = Only usable on machines equipped with sub-spindle.

MAZAK™ • STATIC TOOL RADIAL • KM™ • MMC 019

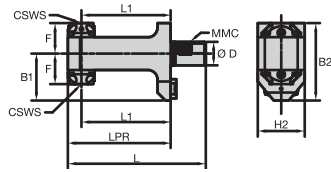

order number	catalogue number	CSWS	MMC	B1	B2	D	F	H2	L	L1	LPR	cp			CF
												Bar	PSI		
6391691	TACU019KM50SR60945554 *	KM50	019	100	165	50	65,0	100	294	190,0	219	100	1500		i

MAZAK • DRIVEN TOOL AXIAL • KM • MMC 019

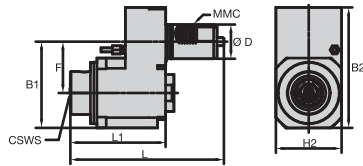
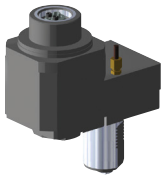

order number	catalogue number	CSWS	MMC	B1	B2	D	F	H2	L	L1	mST (Nm)	cp			CF	CS1	max RPM
												Bar	PSI				
6391675	TACU019KM50DA60945548	KM50	019	126	176	50	75,0	96	225	139,5	100	100	1500	e	G 1/8	4000	
6391676	TACU019KM50DA60945549	KM50	019	126	176	50	75,0	96	225	139,5	100	70	1000	i/e	G 1/8	4000	

MAZAK • DRIVEN TOOL AXIAL • ER™ • MMC 019

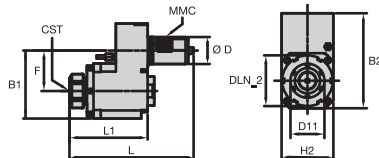
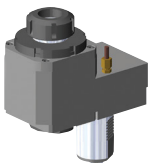

order number	catalogue number	CST	MMC	B1	B2	D	D11	DLN_2	F	H2	L	L1	mST (Nm)	cp			CF	CS1	max RPM
														Bar	PSI				
6588985	TACU019ER40DA61301855	ER40	019	126	176	50	63	94	75,0	96	230	141,5	100	70	1000	i/e	G 1/8	4000	

MAZAK • DRIVEN TOOL RADIAL • KM • MMC 019

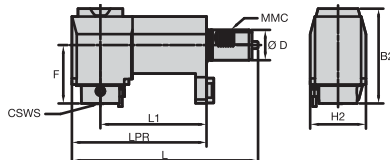

order number	catalogue number	CSWS	MMC	B2	D	F	H2	L	L1	LPR	mST (Nm)	cp			CF	CS1	max RPM
												Bar	PSI				
6391677	TACU019KM50DR60945550	KM50	019	157	50	96,5	92	307	175,0	222	100	100	1500	e	G 1/8	4000	
6391678	TACU019KM50DR60945551	KM50	019	162	50	96,5	92	307	175,0	222	100	70	1000	i/e	G 1/8	4000	



NOTE: * = Only usable on machines equipped with sub-spindle.

MAZAK™ • DRIVEN TOOL RADIAL • ER™ • MMC 019

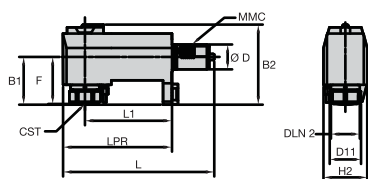

order number	catalogue number	CST	MMC	B1	B2	D	D11	DLN 2	F	H2	L	L1	LPR	cp			max RPM		
														mST (Nm)	Bar	PSI		CF	CS1
6588986	TACU019ER40DR61301856	ER40	019	96	161	50	63	58	94,5	88	304	175,0	219	100	70	1000	i/e	G 1/8	4000

MAZAK • STATIC TOOL AXIAL • KM™ • MMC 020

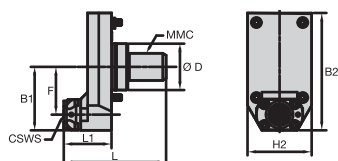
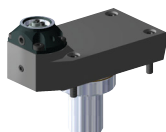

order number	catalogue number	CSWS	MMC	B1	B2	D	F	H2	L	L1	cp		
											Bar	PSI	CF
6391673	TACU020KM40SA60945559	KM40	020	93	172	68	70,0	94	150	70,0	100	1500	i

MAZAK • STATIC TOOL RADIAL • KM • MMC 020

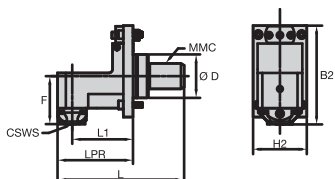

order number	catalogue number	CSWS	MMC	B2	D	F	H2	L	L1	LPR	cp		
											Bar	PSI	CF
6391674	TACU020KM40SR60945560	KM40	020	154	68	75,0	84	198	95,0	118	100	1500	i

MAZAK • DRIVEN TOOL AXIAL • KM • MMC 020

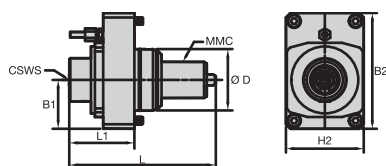
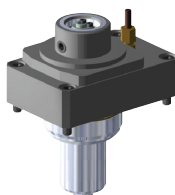

order number	catalogue number	CSWS	MMC	B1	B2	D	H2	L	L1	cp			max RPM		
										mST (Nm)	Bar	PSI		CF	CS1
6391659	TACU020KM40DA60945555	KM40	020	54	128	68	86	162	72,0	50	100	1500	e	G 1/8	6000
6391660	TACU020KM40DA60945556	KM40	020	54	128	68	86	162	72,0	50	25	360	i/e	G 1/8	6000

76	29	4	65

MAZAK™ • DRIVEN TOOL AXIAL • ER™ • MMC 020

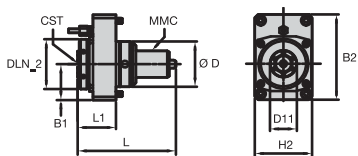
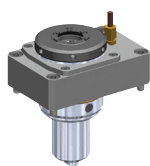

order number	catalogue number	CST	MMC	B1	B2	D	D11	DLN_2	H2	L	L1	mST (Nm)	cp			CF	CS1	max RPM
6588987	TACU020ER32DA61301857	ER32	020	54	128	68	39	75	86	148	55,0	50	25	360	i/e	G 1/8	6000	

MAZAK • DRIVEN TOOL RADIAL • KM™ • MMC 020

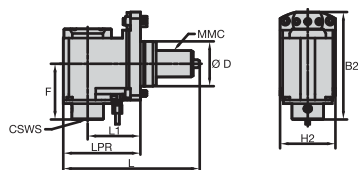

order number	catalogue number	CSWS	MMC	B2	D	F	H2	L	L1	LPR	mST (Nm)	cp			CF	CS1	max RPM
6391671	TACU020KM40DR60945557	KM40	020	163	68	84,5	84	207	80,0	117	50	100	1500	e	G 1/8	6000	
6391672	TACU020KM40DR60945558	KM40	020	163	68	84,5	84	198	80,0	117	50	70	1000	i/e	G 1/8	6000	

MAZAK • DRIVEN TOOL RADIAL • ER • MMC 020

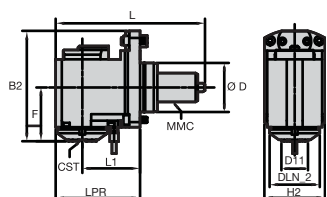
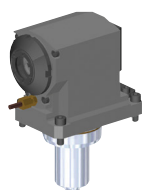

order number	catalogue number	CST	MMC	B2	D	D11	DLN_2	F	H2	L	L1	LPR	mST (Nm)	cp			CF	CS1	max RPM
6588988	TACU020ER32DR61301858	ER32	020	151	68	39	70	72,5	84	207	80,0	117	50	70	1000	i/e	G 1/8	6000	



DMG MORI • STATIC TOOL AXIAL • KM™ • MMC 001

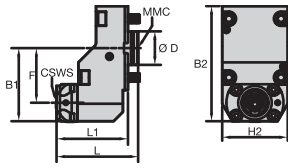

order number	catalogue number	CSWS	MMC	B1	B2	D	F	H2	L	L1	Bar	cp	PSI	CF
6405025	TACU001KM40SA60649623	KM40	001	87	137	40	65,0	78	99	85,0	100		1500	i

DMG MORI • STATIC TOOL AXIAL • KM • MMC 001

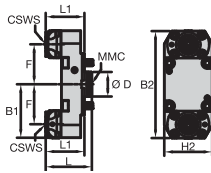
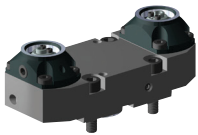

order number	catalogue number	CSWS	MMC	B1	B2	D	F	H2	L	L1	Bar	cp	PSI	CF
6405026	TACU001KM40SA60649626 *	KM40	001	87	174	40	65,0	78	75	63,0	100		1500	i

DMG MORI • STATIC TOOL AXIAL • KM • MMC 001

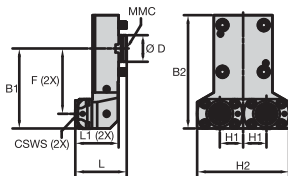

order number	catalogue number	CSWS	MMC	B1	B2	D	F	H1	H2	L	L1	Bar	cp	PSI	CF
6405384	TACU001KM40SA60649631 **	KM40	001	120	170	40	98,0	35	138	77	65,0	100		1500	i



NOTE: * = Only usable on machines equipped with sub-spindle.
 ** = Only usable on machines with "Y" axis capabilities.

DMG MORI • STATIC TOOL RADIAL • KM™ • MMC 001

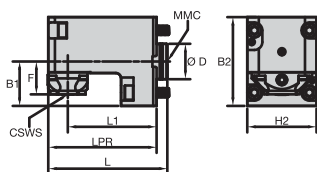

order number	catalogue number	CSWS	MMC	B1	B2	D	F	H2	L	L1	LPR	Bar	cp	PSI	CF
6405027	TACU001KM40SR60649632	KM40	001	50	100	40	37,0	78	134	100,0	122	100		1500	i

DMG MORI • STATIC TOOL RADIAL • KM • MMC 001

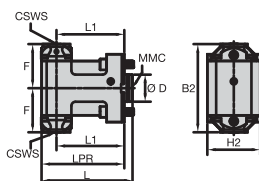

order number	catalogue number	CSWS	MMC	B2	D	F	H2	L	L1	LPR	Bar	cp	PSI	CF
6405028	TACU001KM40SR60649633 *	KM40	001	130	40	65,0	78	134	100,0	122	100		1500	i

DMG MORI • STATIC TOOL RADIAL • KM • MMC 001

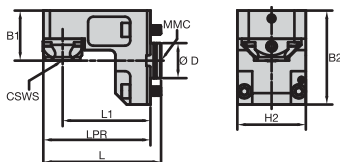

order number	catalogue number	CSWS	MMC	B1	B2	D	H2	L	L1	LPR	Bar	cp	PSI	CF
6405385	TACU001KM40SR60649634	KM40	001	50	107	40	78	134	100,0	122	100		1500	i

DMG MORI • STATIC TOOL RADIAL • KM • MMC 001

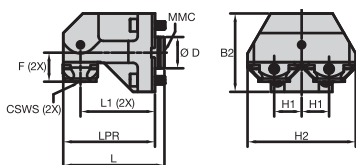

order number	catalogue number	CSWS	MMC	B2	D	F	H1	H2	L	L1	LPR	Bar	cp	PSI	CF
6405386	TACU001KM40SR60649635 **	KM40	001	100	40	37,0	35	138	129	95,0	117	100		1500	i



NOTE: * = Only usable on machines equipped with sub-spindle.
 ** = Only usable on machines with "Y" axis capabilities.

DMG MORI • DRIVEN TOOL AXIAL • KM™ • MMC 001

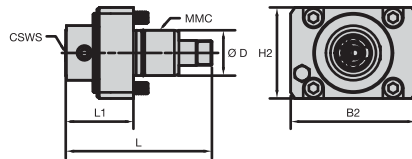

order number	catalogue number	CSWS	MMC	B2	D	H2	L	L1	mST (Nm)	cp		CF	CS1	max RPM
6201237	TACU001KM32DA60648431	KM32	001	110	40	80	124	54,5	32	70	1000	i/e	M12X1	12000
6201238	TACU001KM32DA60648437	KM32	001	110	40	80	124	54,5	32	70	1000	e	M12X1	12000
6201235	TACU001KM40DA60647158	KM40	001	110	40	80	129	59,5	32	70	1000	i/e	M12X1	6000
6201236	TACU001KM40DA60648393	KM40	001	110	40	80	129	59,5	32	70	1000	e	M12X1	6000

DMG MORI • DRIVEN TOOL AXIAL • ER™ • MMC 001

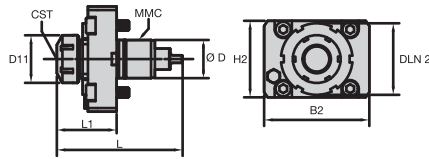
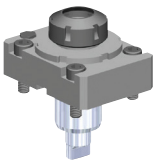

order number	catalogue number	CST	MMC	B2	D	D11	DLN 2	H2	L	L1	mST (Nm)	cp		CF	CS1	max RPM
6588935	TACU001ER25DA61301836	ER25	001	110	40	42	75	80	128	57,0	32	70	1000	i/e	M12X1	12000
6588933	TACU001ER32DA61301834	ER32	001	110	40	50	75	80	132	60,0	32	70	1000	i/e	M12X1	6000

DMG MORI • DRIVEN TOOL RADIAL • KM • MMC 001

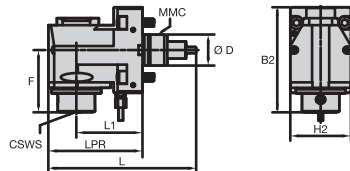
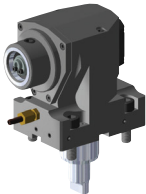

order number	catalogue number	CSWS	MMC	B2	D	F	H2	L	L1	LPR	mST (Nm)	cp		CF	CS1	max RPM
6201263	TACU001KM32DR60648443	KM32	001	128	40	72,5	78	190	85,0	121	32	100	1500	e	G 1/8	12000
6201264	TACU001KM32DR60648444	KM32	001	132	40	72,5	78	190	85,0	121	32	70	1000	i/e	G 1/8	12000
6201239	TACU001KM40DR60648439	KM40	001	135	40	80,0	78	190	85,0	121	32	100	1500	e	G 1/8	6000
6201240	TACU001KM40DR60648440	KM40	001	140	40	80,0	78	190	85,0	121	32	70	1000	i/e	G 1/8	6000

DMG MORI • DRIVEN TOOL RADIAL • KM • MMC 001

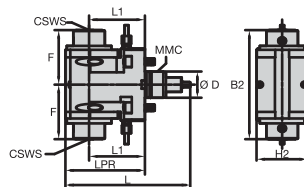
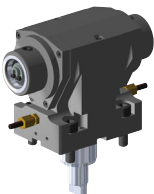

order number	catalogue number	CSWS	MMC	B2	D	F	H2	L	L1	LPR	mST (Nm)	cp		CF	CS1	max RPM
6201261	TACU001KM40DR60648441 *	KM40	001	166	40	83,0	78	190	85,0	121	32	100	1500	e	G 1/8	6000



NOTE: * = Only usable on machines equipped with sub-spindle.

DMG MORI • DRIVEN TOOL RADIAL • KM™ • MMC 001

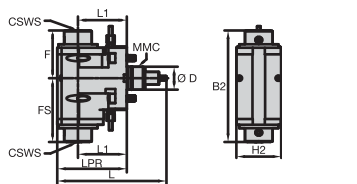
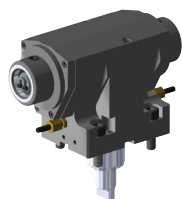

order number	catalogue number	CSWS	MMC	B2	D	F	FS	H2	L	L1	LPR	mST (Nm)	cp		CF	CS1	max RPM
6201262	TACU001KM40DR60648442 *	KM40	001	194	40	83,0	111,0	78	190	85,0	121	32	25	360	i/e	G 1/8	6000

DMG MORI • DRIVEN TOOL RADIAL • ER™ • MMC 001

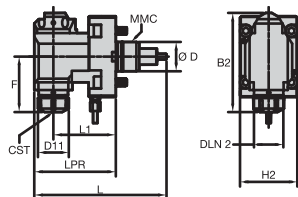
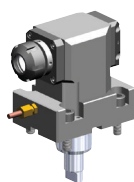

order number	catalogue number	CST	MMC	B2	D	D11	DLN 2	F	H2	L	L1	LPR	mST (Nm)	cp		CF	CS1	max RPM
6588937	TACU001ER25DR61301838	ER25	001	134	40	42	40	74,0	78	180	85,0	111	32	70	1000	i/e	G 1/8	12000
6588934	TACU001ER32DR61301835	ER32	001	138	40	50	47	78,5	78	180	85,0	111	32	70	1000	i/e	G 1/8	6000

DMG MORI • DRIVEN TOOL RADIAL • ER • MMC 001

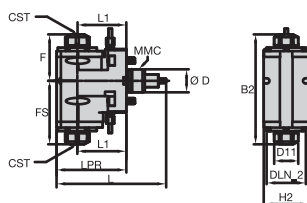
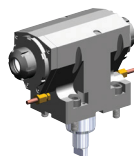

order number	catalogue number	CST	MMC	B2	D	D11	DLN 2	F	FS	H2	L	L1	LPR	mST (Nm)	cp		CF	CS1	max RPM
6588936	TACU001ER25DR61301837 *	ER25	001	188	40	42	68	79,0	108,5	78	190	85,0	121	32	25	360	i/e	G 1/8	6000

DMG MORI • STATIC TOOL AXIAL • KM • MMC 002

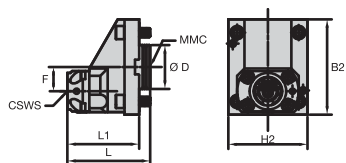

order number	catalogue number	CSWS	MMC	B2	D	F	H2	L	L1	cp		CF
6405029	TACU002KM50SA60649637	KM50	002	130	60	33,0	108	113	98,0	100	1500	i



NOTE: * = Only usable on machines equipped with sub-spindle.

DMG MORI • STATIC TOOL AXIAL • KM™ • MMC 002

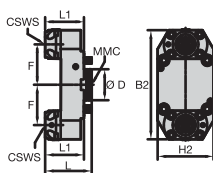
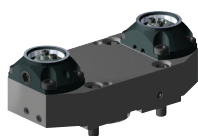

order number	catalogue number	CSWS	MMC	B2	D	F	H2	L	L1	Bar	cp	PSI	CF
6405030	TACU002KM50SA60649638 *	KM50	002	211	60	78,0	108	90	75,0	100		1500	i

DMG MORI • STATIC TOOL RADIAL • KM • MMC 002

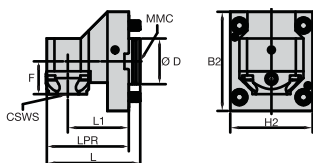

order number	catalogue number	CSWS	MMC	B2	D	F	H2	L	L1	LPR	Bar	cp	PSI	CF
6405381	TACU002KM50SR60649639	KM50	002	130	60	43,0	108	123	80,0	108	100		1500	i

DMG MORI • STATIC TOOL RADIAL • KM • MMC 002

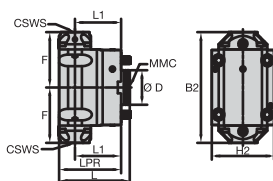

order number	catalogue number	CSWS	MMC	B2	D	F	H2	L	L1	LPR	Bar	cp	PSI	CF
6405382	TACU002KM50SR60649641 *	KM50	002	192	60	96,0	108	123	80,0	108	100		1500	i

DMG MORI • STATIC TOOL RADIAL • KM • MMC 002

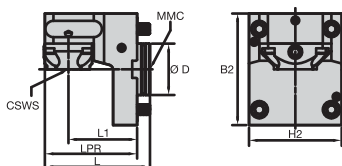

order number	catalogue number	CSWS	MMC	B2	D	H2	L	L1	LPR	Bar	cp	PSI	CF
6405388	TACU002KM50SR60649643	KM50	002	130	60	108	123	80,0	108	100		1500	i



NOTE: * = Only usable on machines equipped with sub-spindle.

DMG MORI • DRIVEN TOOL AXIAL • KM™ • MMC 002

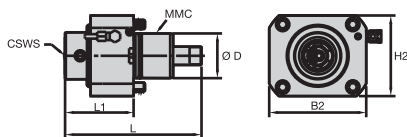

order number	catalogue number	CSWS	MMC	B2	D	H2	L	L1	mST (Nm)	cp Bar	PSI	CF	CS1	max RPM
6201268	TACU002KM40DA60648448	KM40	002	130	60	108	178	86,5	100	70	1000	e	M12X1	10000
6201269	TACU002KM40DA60648449	KM40	002	130	60	108	178	86,5	100	70	1000	i/e	M12X1	10000
6201265	TACU002KM50DA60648445	KM50	002	130	60	108	183	92,0	100	70	1000	e	M12X1	6000
6201266	TACU002KM50DA60648447	KM50	002	130	60	108	184	92,0	100	70	1000	i/e	M12X1	6000

DMG MORI • DRIVEN TOOL AXIAL • ER™ • MMC 002

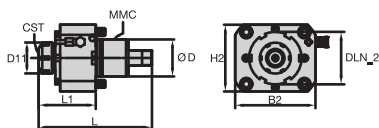

order number	catalogue number	CST	MMC	B2	D	D11	DLN_2	H2	L	L1	mST (Nm)	cp Bar	PSI	CF	CS1	max RPM
6589004	TACU002ER32DA61301864	ER32	002	150	60	50	85	108	184	90,0	100	70	1000	i/e	M12X1 & G 1/8	6000
6589005	TACU002ER32DA61301865	ER32	002	150	60	50	85	108	184	90,0	100	70	1000	i/e	M12X1 & G 1/8	10000
6588939	TACU002ER40DA61301840	ER40	002	150	60	63	89	108	189	94,5	100	70	1000	i/e	M12X1 & G 1/8	6000
6588940	TACU002ER40DA61301841	ER40	002	150	60	63	85	108	189	94,5	100	70	1000	i/e	M12X1 & G 1/8	10000

DMG MORI • DRIVEN TOOL RADIAL • KM • MMC 002

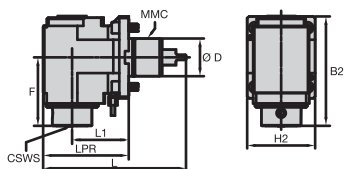
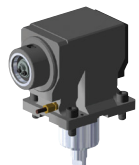

order number	catalogue number	CSWS	MMC	B2	D	F	H2	L	L1	LPR	mST (Nm)	cp Bar	PSI	CF	CS1	max RPM
6201272	TACU002KM40DR60648457	KM40	002	169	60	103,5	108	227	90,0	136	100	100	1500	e	G 1/8	10000
6201273	TACU002KM40DR60648458	KM40	002	169	60	103,5	108	227	90,0	136	100	70	1000	i/e	G 1/8	10000
6201270	TACU002KM50DR60648452	KM50	002	174	60	109,0	108	227	90,0	136	100	100	1500	e	G 1/8	6000
6201271	TACU002KM50DR60648453	KM50	002	175	60	109,0	108	227	90,0	136	100	70	1000	i/e	G 1/8	6000

DMG MORI • DRIVEN TOOL RADIAL • KM • MMC 002

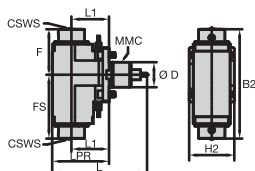
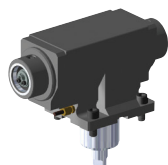

order number	catalogue number	CSWS	MMC	B2	D	F	FS	H2	L	L1	LPR	mST (Nm)	cp Bar	PSI	CF	CS1	max RPM
6201274	TACU002KM50DR60648459 *	KM50	002	224	60	109,0	115,0	108	227	90,0	136	100	100	1500	e	G 1/8	6000
6201275	TACU002KM50DR60648460 *	KM50	002	262	60	109,0	153,0	108	227	90,0	136	100	25	360	i/e	G 1/8	6000



NOTE: * = Only usable on machines equipped with sub-spindle.

DMG MORI • DRIVEN TOOL RADIAL • ER™ • MMC 002

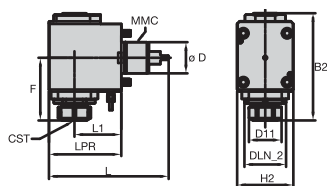

order number	catalogue number	CST	MMC	B2	D	D11	DLN_2	F	H2	L	L1	LPR	mST (Nm)	cp		CF	CS1	max RPM
6589003	TACU002ER32DR61301863	ER32	002	202	60	50	80	116,5	108	230	90,0	139	100	70	1000	i/e	G 1/8	6000
6588938	TACU002ER40DR61301839	ER40	002	204	60	63	80	118,5	108	230	90,0	139	100	70	1000	i/e	G 1/8	6000
6588961	TACU002ER40DR61301842	ER40	002	204	60	63	80	118,5	108	230	90,0	139	100	70	1000	i/e	G 1/8	10000

DMG MORI • DRIVEN TOOL RADIAL • ER • MMC 002

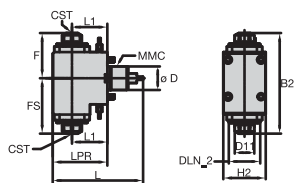
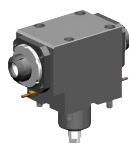

order number	catalogue number	CST	MMC	B2	D	D11	DLN_2	F	FS	H2	L	L1	LPR	mST (Nm)	cp		CF	CS1	max RPM
6589006	TACU002ER32DR61301866 *	ER32	002	251	60	50	80	112,5	138,5	108	230	90,0	138	100	25	360	i/e	G 1/8	6000
6588962	TACU002ER40DR61301843 *	ER40	002	260	60	63	80	117,0	143,0	108	230	90,0	139	100	25	360	i/e	G 1/8	6000



NOTE: * = Only usable on machines equipped with sub-spindle.

OKUMA™ • STATIC TOOL AXIAL • KM™ • MMC 009

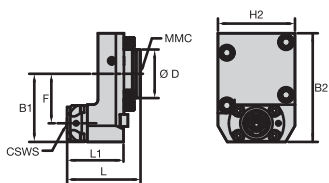

order number	catalogue number	CSWS	MMC	B1	B2	D	F	H2	L	L1	cp		
6411222	TACU009KM40SA60907362	KM40	009	84	134	60	61,0	95	91	70,0	Bar	PSI	CF
											100	1500	i

OKUMA • STATIC TOOL AXIAL • KM • MMC 009

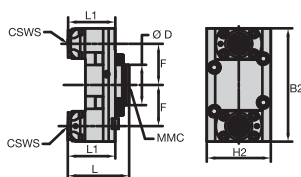
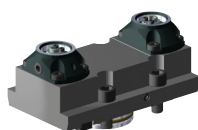

order number	catalogue number	CSWS	MMC	B2	D	F	H2	L	L1	cp		
6411223	TACU009KM40SA60907363 *	KM40	009	168	60	61,0	95	91	70,0	Bar	PSI	CF
										100	1500	i

OKUMA • STATIC TOOL RADIAL • KM • MMC 009

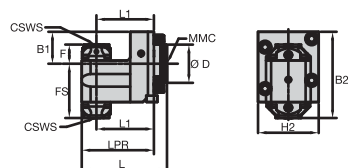

order number	catalogue number	CSWS	MMC	B1	B2	D	F	FS	H2	L	L1	LPR	cp		
6411226	TACU009KM40SR60907371 *	KM40	009	50	135	60	30,0	85,0	95	134	90,0	113	Bar	PSI	CF
													100	1500	i

OKUMA • DRIVEN TOOL AXIAL • KM • MMC 009

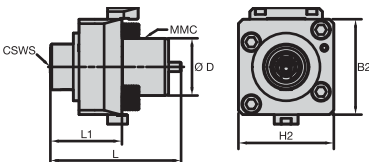
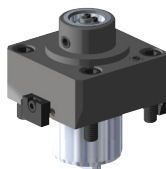

order number	catalogue number	CSWS	MMC	B2	D	H2	L	L1	mST (Nm)	cp			max RPM
6411158	TACU009KM40DA60907348	KM40	009	100	60	100	137	75,0	50	Bar	PSI	CF	CS1
6411159	TACU009KM40DA60907349	KM40	009	100	60	100	137	75,0	50	70	1000	e	M12X1
									50	70	1000	i/e	M12X1



NOTE: * = Only usable on machines equipped with sub-spindle.

OKUMA™ • DRIVEN TOOL AXIAL • ER™ • MMC 009

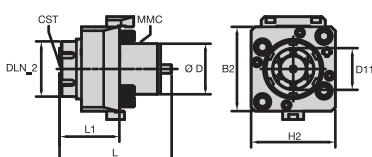

order number	catalogue number	CST	MMC	B2	D	D11	DLN_2	H2	L	L1	mST (Nm)	cp			max RPM	
6588964	TACU009ER40DA61301844	ER40	009	100	60	49	66	100	133	69,0	50	70	1000	i/e	M12X1	6000

OKUMA • DRIVEN TOOL RADIAL • KM™ • MMC 009

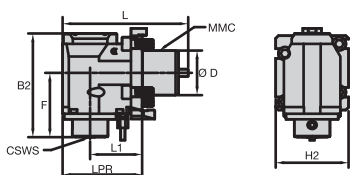
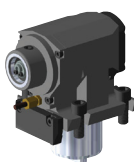

order number	catalogue number	CSWS	MMC	B2	D	F	H2	L	L1	LPR	mST (Nm)	cp			max RPM	
6411160	TACU009KM40DR60907352	KM40	009	140	60	86,5	98	169	70,0	107	50	100	1500	e	G 1/8	6000
6411221	TACU009KM40DR60907354	KM40	009	144	60	86,5	98	169	70,0	107	50	70	1000	i/e	G 1/8	6000

OKUMA • DRIVEN TOOL RADIAL • KM • MMC 009

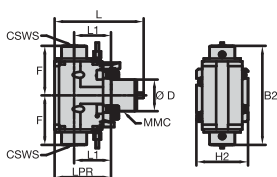
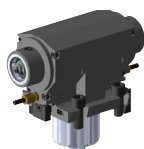

order number	catalogue number	CSWS	MMC	B2	D	F	H2	L	L1	LPR	mST (Nm)	cp			max RPM	
6411224	TACU009KM40DR60907355 *	KM40	009	188	60	94,0	98	169	70,0	107	50	100	1500	e	G 1/8	6000

OKUMA • DRIVEN TOOL RADIAL • KM • MMC 009

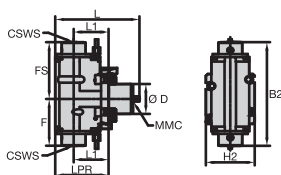
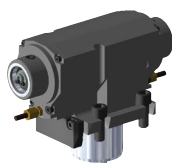

order number	catalogue number	CSWS	MMC	B2	D	F	FS	H2	L	L1	LPR	mST (Nm)	cp			max RPM	
6411225	TACU009KM40DR60907357 *	KM40	009	208	60	94,0	114,0	98	169	70,0	107	50	25	360	i/e	G 1/8	6000



NOTE: * = Only usable on machines equipped with sub-spindle.

OKUMA™ • DRIVEN TOOL RADIAL • ER™ • MMC 009

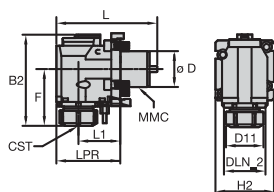
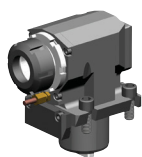

order number	catalogue number	CST	MMC	B2	D	D11	DLN 2	F	H2	L	L1	LPR	cp			max RPM		
													mST (Nm)	Bar	PSI		CF	CS1
6588965	TACU009ER40DR61301845	ER40	009	151	60	63	70	91,5	98	169	70,0	107	50	70	1000	i/e	G 1/8	6000

OKUMA • DRIVEN TOOL RADIAL • ER • MMC 009

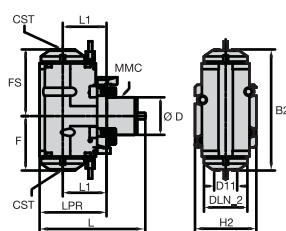

order number	catalogue number	CST	MMC	B2	D	D11	DLN 2	F	FS	H2	L	L1	LPR	cp			max RPM		
														mST (Nm)	Bar	PSI		CF	CS1
6588966	TACU009ER32DR61301846 *	ER32	009	190	60	39	69	85,0	104,5	98	169	70,0	107	50	70	1000	i/e	G 1/8	6000

OKUMA • STATIC TOOL RADIAL • KM™ • MMC 013

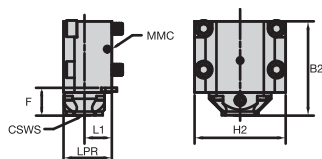

order number	catalogue number	CSTWS	MMC	B2	F	H2	L1	LPR	cp		
									Bar	PSI	CF
6391732	TACU013KM40SR60907381	KM40	013	103	30,0	100	30,0	53	100	1500	i
6391733	TACU013KM50SR60907382	KM50	013	108	35,0	100	40,0	69	100	1500	i



NOTE: * = Only usable on machines equipped with sub-spindle.

NOVO™

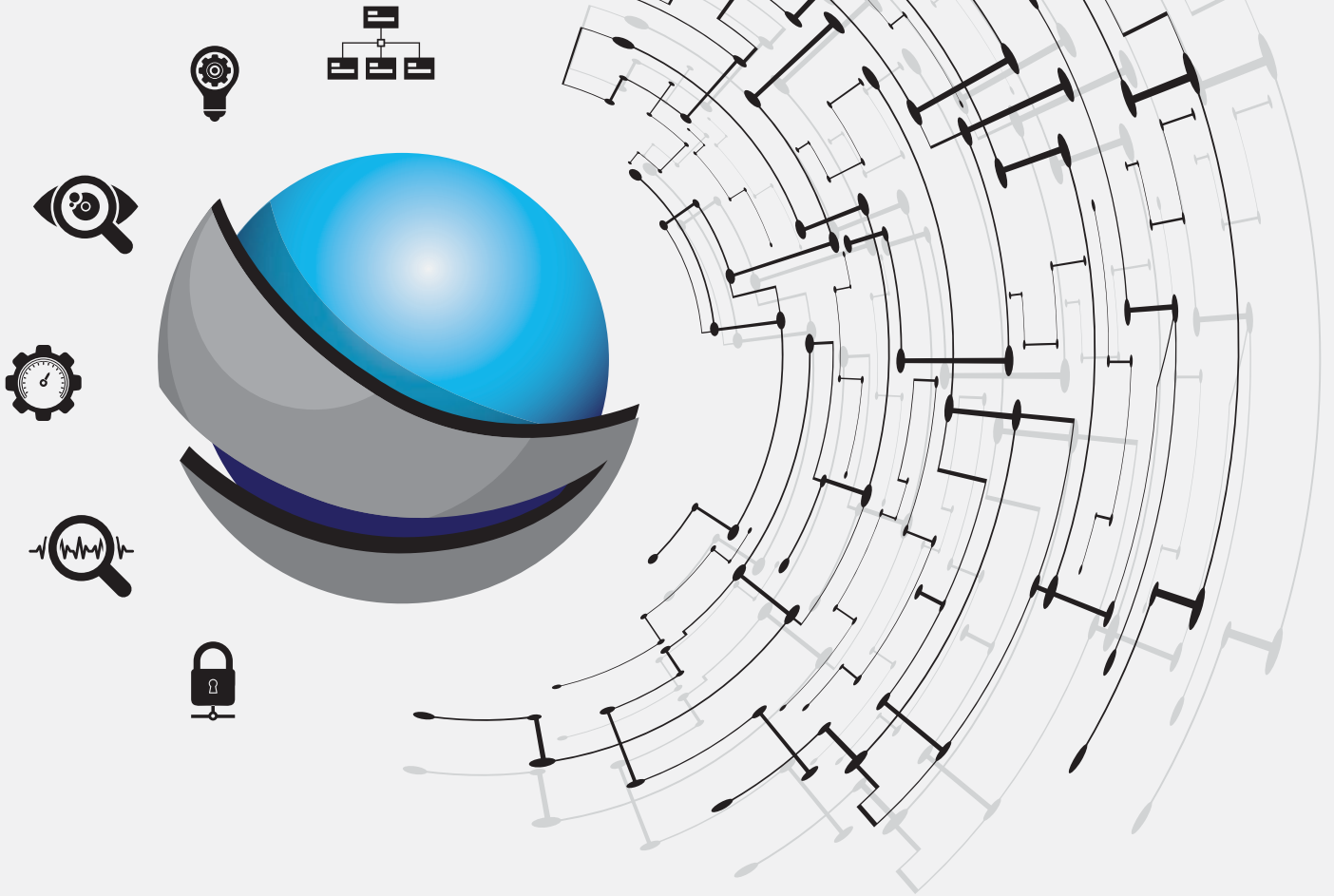

**Digitally access and leverage product data and knowledge
to connect systems and processes throughout
the entire manufacturing lifecycle.**

VISIT KENNAMETAL.COM/NOVO AND DOWNLOAD TODAY.

VDI Turret Blocks

- Quick change with single clamping wedge.
- Tool alignment by fine adjustment.
- VDI orientation according to machine specification.



BMT Turret Blocks

- 4 bolts to mount on to the turret.
- Additional alignment not required.
- Offers the highest rigidity, which is ideal for a wide range of applications.

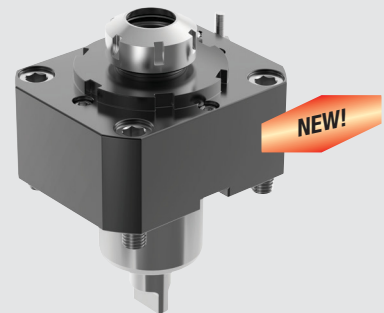

Coolant supply options for static and driven tools:

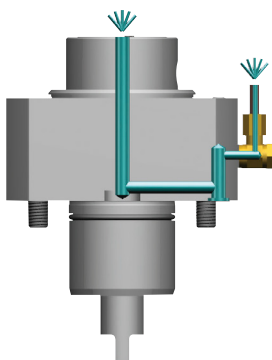

Driven tools with internal and external coolant

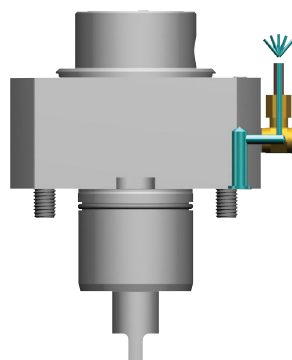

Driven tool external coolant

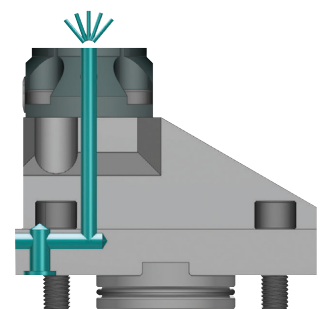

Static tool internal coolant

NOTE: Driven tools with internal coolant cannot be run dry and require a minimum 50 micron coolant filtration.
Gear ratio is 1:1, unless specified otherwise.
Please visit kennametal.com to download detailed drawings and models.

TACU MOUNTING SPECIFICATIONS

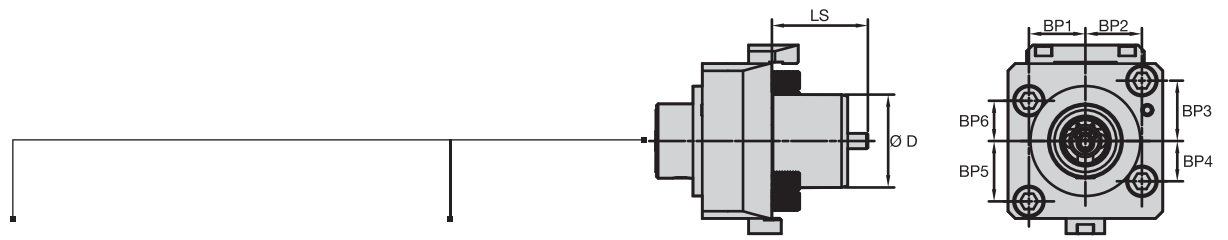

KM™-Locking Torque Values

KM Size	[Torque] Nm
32	8-11
40	12-16
50	27-34
63	47-54

ER-Locknut Torque Values

ER Size	diameter mm	[Torque] Nm
25	1,0-3,5	24
25	4,0-4,5	56
25	5,0-7,5	80
25	8,0-17,0	104
32	2,0-2,5	24
32	3,0-7,5	136
32	8,0-22,0	136
40	3,0-26,0	176

Machine Mounting Code	Machine Builder	Mounting Style	Tool Type	BP1	BP2	BP3	BP4	BP5	BP6	D	LS	Torque Nm	Mounting Bolt
001	DMG Mori	BMT40	Driven	31	31	35	35	35	35	40	69	50	M10 x 1,5
			Static	31	31	35	35	35	35	40	12		
002	DMG Mori	BMT60	Driven	42	42	47	47	47	47	60	91	90	M12 x 1,75
			Static	42	42	47	47	47	47	60	15		
009	OKUMA™	BMT60	Driven	36,5	36,5	39	26	39	26	60	62	90	M12 x 1,75
			Static	36,5	36,5	39	26	39	26	60	20		
013	HAAS™, OKUMA	Keyed	Static	40	40	22,5	22,5	22,5	22,5	-	-	90	M12 x 1,75
016	Mazak™	VDI40-Mazak	Driven	-	-	-	-	-	-	40	78	-	-
			Static	-	-	-	-	-	-	40	51		
017	Mazak	VDI40	Driven	-	-	-	-	-	-	40	78	-	-
			Static	-	-	-	-	-	-	40	51		
018	Mazak	VDI50-Mazak	Driven	-	-	-	-	-	-	50	85	-	-
			Static	-	-	-	-	-	-	50	75		
019	Mazak	VDI50-Mazak	Driven	-	-	-	-	-	-	50	85	-	-
			Static	-	-	-	-	-	-	50	75		
020	Mazak	BMT68	Driven	34	34	65	45	65	45	68	90	25	M8 x 1,25
			Static	34	34	65	45	65	45	68	90		
035	DOOSAN™, HWACHEON™, HYUNDAI WIA	BMT55	Driven	32	32	32	32	32	32	55	104	50	M10 x 1,5
			Static	32	32	32	32	32	32	-	-		
036	DOOSAN, HWACHEON, HYUNDAI WIA	BMT65	Driven	36,5	36,5	35	35	35	35	65	112	90	M12 x 1,75
			Static	36,5	36,5	35	35	35	35	-	-		

NOTE: See page 28 for tool selection guide.

VDI

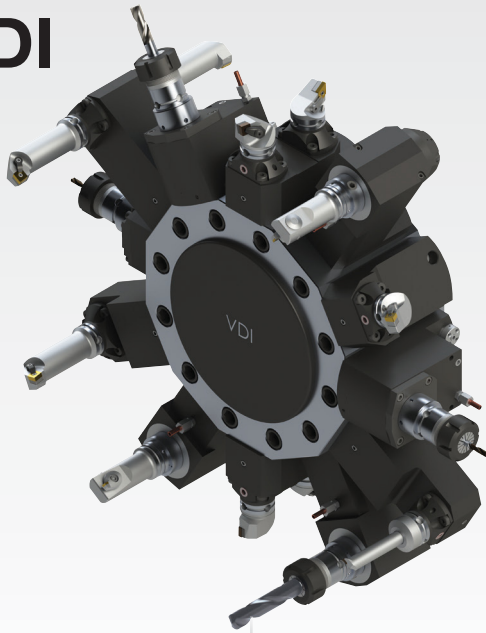

BMT

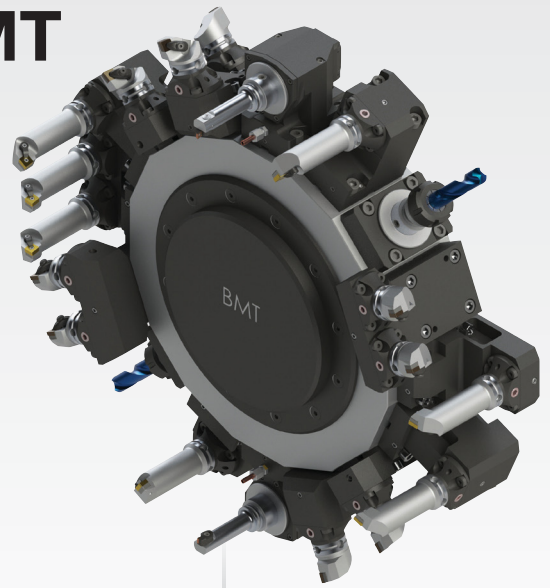

Driven & Static Units
 KM™ sizes 32, 40, 50, 63

Driven Units
 ER™ sizes 25, 32, 40

Internal Cutting Units

HydroForce™ Hydraulic Chucks

Beyond™ Evolution™ Grooving and Cut-Off

Shell Mill Adaptors

External Cutting Units

KM Extension

Option 1

NEW!

See page 70.

With Solid ER Collet

Option 2

With Standard ER Collet

TOOLING LAYOUT FOR CNC-LATHE WITH DRIVEN AND STATIC TOOLS

Need more help? Please fill in the information below and we can get you the answers you need.

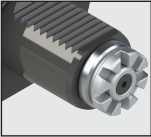
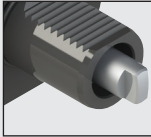
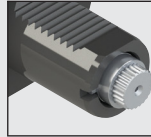
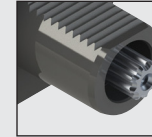
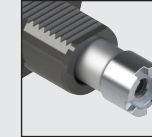
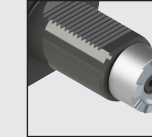
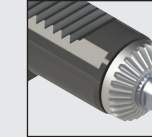
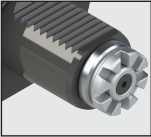
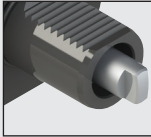
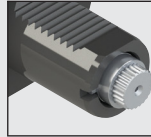
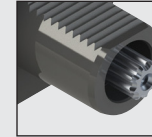
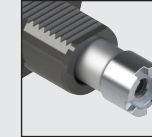
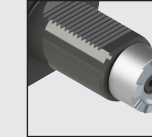
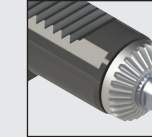
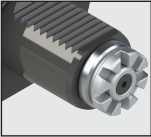
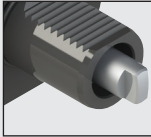
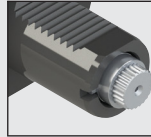
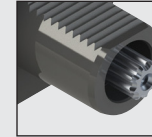
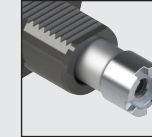
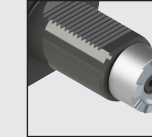
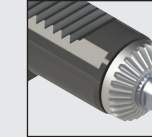
Tooling Layout for CNC-Lathe with Driven and Static Tools															
Machine Type (for example: DMG Mori, Mazak™, Okuma™...):															
Model/Type (for example: NL2000, MP6200Y, LT300...):	Date of construction:														
Shank Ø (DIN 69880 or relevant)	<table style="width: 100%; border: none;"> <tr> <td style="width: 50%;">VDI:</td> <td style="width: 50%;">BMT:</td> </tr> <tr> <td><input type="radio"/> 16mm</td> <td><input type="radio"/> 55mm</td> </tr> <tr> <td><input type="radio"/> 20mm</td> <td><input type="radio"/> 65mm</td> </tr> <tr> <td><input type="radio"/> 30mm</td> <td><input type="radio"/> 75mm</td> </tr> <tr> <td><input type="radio"/> 40mm</td> <td><input type="radio"/> 85mm</td> </tr> <tr> <td><input type="radio"/> _____</td> <td><input type="radio"/> _____</td> </tr> </table>	VDI:	BMT:	<input type="radio"/> 16mm	<input type="radio"/> 55mm	<input type="radio"/> 20mm	<input type="radio"/> 65mm	<input type="radio"/> 30mm	<input type="radio"/> 75mm	<input type="radio"/> 40mm	<input type="radio"/> 85mm	<input type="radio"/> _____	<input type="radio"/> _____		
VDI:	BMT:														
<input type="radio"/> 16mm	<input type="radio"/> 55mm														
<input type="radio"/> 20mm	<input type="radio"/> 65mm														
<input type="radio"/> 30mm	<input type="radio"/> 75mm														
<input type="radio"/> 40mm	<input type="radio"/> 85mm														
<input type="radio"/> _____	<input type="radio"/> _____														
Turret Type	<input type="radio"/> Star <input type="radio"/> Crown <input type="radio"/> Disc														
Is the turret an original type?	<input type="radio"/> Yes <input type="radio"/> No														
If no, which turret type?	<input type="radio"/> Sauter <input type="radio"/> Baruffaldi <input type="radio"/> Diplomatic <input type="radio"/> Others: _____														
Turret type number (for example: Sauter 05.473.516):															
Tool positions on turret?	<input type="radio"/> 12 <input type="radio"/> 20 <input type="radio"/> 16 <input type="radio"/> ____														
Quantity of driven positions?	Quantity:														
If more turrets are used, please specify turret-no.:	Turret-Number:														
Which kind of drive (coupling, interface)? (f.e.: DIN 1809, 5480, 5482)	DIN:														
<table style="width: 100%; text-align: center;"> <tr> <td></td> <td></td> <td></td> <td></td> <td></td> <td></td> <td></td> </tr> <tr> <td><input type="radio"/> Baruffaldi TOEM</td> <td><input type="radio"/> DIN 1809</td> <td><input type="radio"/> DIN 5480</td> <td><input type="radio"/> DIN 5482</td> <td><input type="radio"/> 1 Step Front Coupling</td> <td><input type="radio"/> 2 Step Front Coupling</td> <td><input type="radio"/> Bevel Gear</td> </tr> </table>								<input type="radio"/> Baruffaldi TOEM	<input type="radio"/> DIN 1809	<input type="radio"/> DIN 5480	<input type="radio"/> DIN 5482	<input type="radio"/> 1 Step Front Coupling	<input type="radio"/> 2 Step Front Coupling	<input type="radio"/> Bevel Gear	
															
<input type="radio"/> Baruffaldi TOEM	<input type="radio"/> DIN 1809	<input type="radio"/> DIN 5480	<input type="radio"/> DIN 5482	<input type="radio"/> 1 Step Front Coupling	<input type="radio"/> 2 Step Front Coupling	<input type="radio"/> Bevel Gear									
Which version is required?	<input type="radio"/> (R) right version <input type="radio"/> (L) left version <input type="radio"/> (RL) double serration														
Ratio (more speed) (more torque)	<table style="width: 100%;"> <tr> <td><input type="radio"/> i = 1:1</td> <td><input type="radio"/> i = 1:2</td> <td><input type="radio"/> i = 1:3</td> <td><input type="radio"/> i = 1:4</td> <td><input type="radio"/> i = 1:5</td> <td><input type="radio"/> i = 1 : ____</td> </tr> <tr> <td><input type="radio"/> i = 2:1</td> <td><input type="radio"/> i = 3:1</td> <td></td> <td></td> <td></td> <td><input type="radio"/> i = ____ : 1</td> </tr> </table>	<input type="radio"/> i = 1:1	<input type="radio"/> i = 1:2	<input type="radio"/> i = 1:3	<input type="radio"/> i = 1:4	<input type="radio"/> i = 1:5	<input type="radio"/> i = 1 : ____	<input type="radio"/> i = 2:1	<input type="radio"/> i = 3:1				<input type="radio"/> i = ____ : 1		
<input type="radio"/> i = 1:1	<input type="radio"/> i = 1:2	<input type="radio"/> i = 1:3	<input type="radio"/> i = 1:4	<input type="radio"/> i = 1:5	<input type="radio"/> i = 1 : ____										
<input type="radio"/> i = 2:1	<input type="radio"/> i = 3:1				<input type="radio"/> i = ____ : 1										
Rotating direction	<input type="radio"/> cw (in) – cw (out) <input type="radio"/> cw (in) – ccw (out)														
Orientation of axial tools	<input type="radio"/> standard <input type="radio"/> offset of _____mm														
NOTE: For machines with star-turret for axial processing, you need RADIAL TOOLS and inverse															
Orientation of radial tools	<input type="radio"/> standard <input type="radio"/> back offset of _____mm														
NOTE: For machines with star-turret for radial processing, you need AXIAL TOOLS and inverse															
Which style of toolholding do you prefer?	<table style="width: 100%;"> <tr> <td><input type="radio"/> ER (ESX)</td> <td><input type="radio"/> Shell Mill</td> </tr> <tr> <td><input type="radio"/> TAP</td> <td><input type="radio"/> Weldon®/WN</td> </tr> <tr> <td><input type="radio"/> ABS</td> <td><input type="radio"/> KM™</td> </tr> <tr> <td><input type="radio"/> PSC</td> <td><input type="radio"/> HSK</td> </tr> </table>	<input type="radio"/> ER (ESX)	<input type="radio"/> Shell Mill	<input type="radio"/> TAP	<input type="radio"/> Weldon®/WN	<input type="radio"/> ABS	<input type="radio"/> KM™	<input type="radio"/> PSC	<input type="radio"/> HSK						
<input type="radio"/> ER (ESX)	<input type="radio"/> Shell Mill														
<input type="radio"/> TAP	<input type="radio"/> Weldon®/WN														
<input type="radio"/> ABS	<input type="radio"/> KM™														
<input type="radio"/> PSC	<input type="radio"/> HSK														
Collet size, shell mill Ø, Weldon®/Whistle Notch Ø, (f.e.: 16, 25, 40....)	Size: _____														
Remarks: (for example: inner coolant supply, a.s.o. ...)															

Threaded Solid ER Collets

Adapt Screw-On Milling Cutters
to CNC Lathes



kennametal.com/ER-Solid-Collets

Threaded solid ER collets turn CNC lathe machines into multitasking machines by providing access of any small diameter screw-on milling cutter to ER driven units.

These new solid ER collets increase machine utilisation through modular flexibility.

The short projection from the face of the collet nut provides rigid toolholding and a smaller required machine envelope.

Compatible with all standard ER collet chucks and ER driven units.



Portfolio

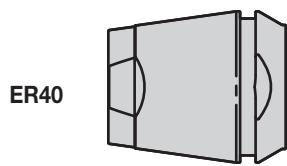

Thread Sizes

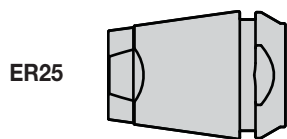
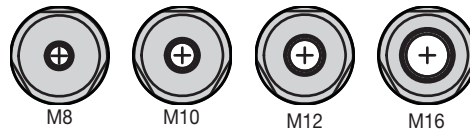
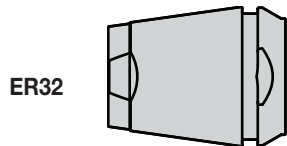
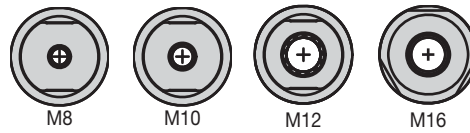

SOLID ER COLLETS

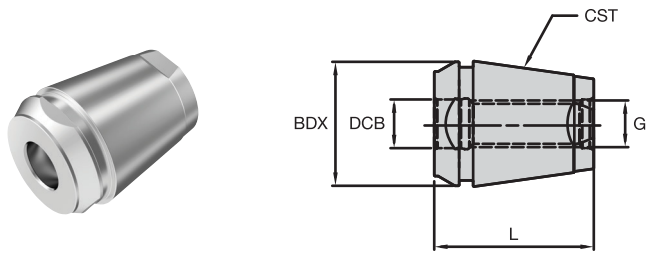

order number	catalogue number	CST	DCB	G	BDX	L	kg	Nm
6587968	ER25STM08	ER25	9	M8	26	35	0,1	20
6587969	ER25STM10	ER25	11	M10	26	35	0,1	40
6587970	ER25STM12	ER25	13	M12	26	35	0,1	60
6588001	ER32STM08	ER32	9	M8	33	41	0,2	20
6588002	ER32STM10	ER32	11	M10	33	41	0,2	40
6588003	ER32STM12	ER32	13	M12	33	41	0,2	60
6588004	ER32STM16	ER32	17	M16	33	41	0,1	80
6588005	ER40STM08	ER40	9	M8	41	47	0,4	20
6588006	ER40STM10	ER40	11	M10	41	47	0,3	40
6588007	ER40STM12	ER40	13	M12	41	47	0,3	60
6588008	ER40STM16	ER40	17	M16	41	47	0,3	80

76	—	4	65

Spare Parts & Accessories Information

1 STEP 1 Enter the tool catalogue number here

KENNAMETAL

Search By Keyword, Part #, ANSI/ISO

PRODUCTS SOLUTIONS SERVICES RESOURCES SUPPORT ABOUT US

English / Products / Metalworking Tools / Milling / Indexable Milling / Milling Inch Tools / Face Mills / Mill 16 / Mill 16 • Shell Mills

Mill 16™

Shell Mills

Features and Benefits

- Productivity booster for machining cast iron materials.
- Insert with 16 cutting edges.

SPECIFICATIONS

Mill 16 • Shell Mills • Wedge Clamping

Show 10 entries

order number	catalog number	D1	D1 max	D	D6	L	Ap1 max	Z	lbs	max RPM
6001979	MILL16E200Z05ON08W	2.000	2.495	.750	2.000	2.000	215	5	1.45	11100

2 STEP 2 Select the spare parts & accessories

PRODUCT USAGE /

Insert Selection Inserts Tool Body Speeds & Feeds Grades Spare Parts

Spare Parts

D1	wedge	wedge screw	in. lbs.	wrench	mounting screw with coolant grooves	adjustable torque wrench	bit SW3 for adjustable torque wrench
2.000	CW16	12748601000	62	12148044900	KLSS0714C	DTQ50140	BTQSW3L90

**Lost a screw? Have to replace worn-out clamping wedges?
Need to find and re-order those spare parts?**

GO TO **KENNAMETAL.COM** AND FIND WHAT YOU NEED IN SECONDS.

INDEXABLE MILLING

wear resistance ← → toughness

Coating		Grade Description		05	10	15	20	25	30	35	40	45		
KC522M		Coated carbide grade with a AlTiN (PVD) coating. KC522M is engineered to provide better performance in general machining of high-temperature alloys and stainless steel. KC522M resists breakage and offers improved wear resistance and increased strength.	P											
			M											
			K											
			S											
KCK15		Coated carbide grade with CVD multilayer coating (TiN/MT TiCN/Al ₂ O ₃) and advanced Beyond™ post-coat treatment. KCK15 is a wear-resistant grade with balanced toughness for general milling of cast irons at higher speeds. Best results in dry, but can also be used wet.												
			K											
KCK20		A new PVD multilayer AlTiN + AlCrN coated carbide with an excellent combination of wear resistance and coating strength. The KCK20 grade is specifically engineered to maximise coating adhesion and edge strength, making this grade ideal in wet interrupted cutting of grey and ductile irons, and can also be used in dry conditions. It can be used in a wide range of applications, from finishing to roughing, to maximise productivity wherever strength and reliability are needed.												
			K											
KCPK30		Coated carbide grade with CVD multilayer (TiN/TiCN/Al ₂ O ₃) and advanced Beyond™ post-coat treatment. Substrate is very tough. KCPK30 has a wide application area in general and roughing milling of steels and cast irons. Performs best dry, but can also be used wet.	P											
			K											
KCPM40		Coated carbide grade with an advanced PVD TiAlN/AlCrN coating. Tough substrate with excellent capability at higher temperatures. KCPM40™ is the first choice for milling steel and stainless steel. Good thermal shock resistance makes this grade ideal for both wet and dry machining. Primarily for use in general and heavy machining.	P											
			M											
KCSM40		Coated carbide grade with an advanced PVD TiAlN/TiN coating. Premium substrate with newly developed binder composition. KCSM40 is a high-performance grade for titanium, super alloys, and stainless steel. High thermal shock resistance of the substrate makes this grade ideal for wet machining. First choice for roughing and unsuitable cutting conditions.	M											
			S											
KC725M		Coated carbide grade with an advanced PVD TiAlN coating. KC725M is a high-performance grade for milling steel, stainless steel, and ductile cast iron. The good thermal shock resistance of the substrate makes this grade ideal for both wet and dry machining. Primarily for use in general and heavy machining.	P											
			M											
			S											



SOLID CARBIDE END MILLING

wear resistance ← → toughness

Coating		Grade Description		05	10	15	20	25	30	35	40	45		
KC643M			Coated fine-grain grade with PVD multilayer (AlTiN). KC643M™ is a very thin and hard PVD coating particularly suited for cutting steel, cast iron, stainless steel (wet), and titanium (wet). This grade can be used for materials with hardness up to 52 HRC.	P			█	█	█	█				
		M				█	█	█	█					
		K				█	█	█	█					
		S				█	█	█	█					

KEY TO PRODUCT TABLE COLUMN HEADINGS

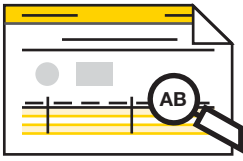

You may notice a slight change in the appearance of our product tables and specification charts. In this catalogue, Kennametal introduces a set of short-name codes to improve the readability of tables and drawings. These codes replace full-text descriptions. The full list of codes and their definitions can be found below.

SHORT-NAME CODE	FULL TEXT DESCRIPTION
Ap1 max	Maximum Cutting Depth
B1	Front Clearance
B2	Overall Width
Bar	Coolant Pressure Bar
CE	Cutting Edges
CF	Coolant Feature: i = internal e = external i/e = internal and external
cp	Coolant Pressure
CS1	External Coolant, Coolant Supply Exit Size
CSMS	Connection Style Machine Side
CST	Collet Series
CSWS	Connection Style Workpiece Side
D	Insert: Insert IC Size
D	Milling: Mounting Diameter
D	Toolholder: Shank/Bore Diameter
D1	Milling: Cutter Diameter
D1	Toolholder: Clamping Diameter
D4	Bolt Circle Diameter
D6	Hub Diameter
D11	Lock Nut Diameter
DLN_2	Spindle Nut Diameter
F	F Dimension
FS	Secondary F dimension
H1	Centreline Height
H2	Overall Height
L	Overall Length
L1	Gage Length
LI	Insert Length
LPR	Protruding Length
max RPM	Maximum Revolutions Per Minute
MMC	Machine Mount Code
mST (Nm)	Max Spindle Torque (Nm)
Nm	Torque Nm
PSI	Coolant Pressure PSI
R _c	Corner Radius
S	Insert Thickness
W	Cutting Edge Width or Slot Width
Z	Number of Inserts

P	Steel
M	Stainless Steel
K	Cast Iron

N	Non-Ferrous
S	High-Temp Alloys

H	Hardened Materials
C	CFRP Materials

material group	description	content	tensile strength RM (MPa)*	hardness (HB)	hardness (HRC)	material number
P0	Low-Carbon Steels, Long Chipping	C <0,25%	<530	<125	-	-
P1	Low-Carbon Steels, Short Chipping, Free Machining	C <0,25%	<530	<125	-	C15, Ck22, ST37-2, S235JR, 9SMnPb28, GS38
P2	Medium- and High-Carbon Steels	C >0,25%	>530	<220	<25	ST52, S355JR, C35, GS60, Cf53
P3	Alloy Steels and Tool Steels	C >0,25%	600-850	<330	<35	16MnCr5, Ck45, 21CrMoV5-7, 38SMn28
P4	Alloy Steels and Tool Steels	C >0,25%	850-1400	340-450	35-48	100Cr6, 30CrNiMo8, 42CrMo4, C70W2, S6525, X120Mn12
P5	Ferritic, Martensitic, and PH Stainless Steels	-	600-900	<330	<35	100Cr6, 30CrNiMo8, 42CrMo4, C70W2, S6525, X120Mn12
P6	High-Strength Ferritic, Martensitic, and PH Stainless Steels	-	900-1350	350-450	35-48	X102CrMo17, G-X120Cr29
M1	Austenitic Stainless Steel	-	<600	130-200	-	X5CrNi 18 10, X2CrNiMo 17 13 2, G-X25CrNiSi18 9, X15CrNiSi 20 12
M2	High-Strength Austenitic Stainless and Cast Stainless Steels	-	600-800	150-230	<25	X2CrNiMo 13 4, X5NiCr 32 21, X5CrNiNb 18 10, G-X15CrNi 25-20
M3	Duplex Stainless Steel	-	<800	135-275	<30	X8CrNiMo27 5, X2CrNiMoN22 5 3, X20CrNiSi25 4, G-X40CrNiSi27 4
K1	Grey Cast Iron	-	125-500	120-290	<32	GG15, GG25, GG30, GG40, GTW40
K2	Low- and Medium-Strength Ductile Irons (Nodular Irons) and Compacted Graphite Irons (CGI)	-	<600	130-260	<28	GGG40, GTS35
K3	High-Strength Ductile Irons and Austempered Ductile Iron (ADI)	-	>600	180-350	<43	GGG60, GTW55, GTS65
N1	Wrought Aluminium	-	-	-	-	AlMg1, Al99.5, AlCuMg1, AlCuBiPb, AlMgSi1, AlMgSiPb
N2	Low-Silicon Aluminium Alloys and Magnesium Alloys	Si <12,2%	-	-	-	GAISiCu4, GDAISI10Mg
N3	High-Silicon Aluminium Alloys and Magnesium Alloys	Si >12,2%	-	-	-	G-ALSi12, G-ALSi17Cu4, G-ALSi21CuNiMg
N4	Copper-, Brass-, Zinc-Based on Machinability Index Range of 70-100	-	-	-	-	CuZn40, Ms60, G-CuSn5ZnPb, CuZn37, CuSi3Mn
N5	Nylon, Plastics, Rubbers, Phenolics, Resins, Fibreglass	-	-	-	-	Lexan®, Hostalen®, Polystyrol, Makrolon®
N6	Carbon, Graphite Composites, CFRP	-	-	-	-	CFK, GFK
N7	Metal Matrix Composites (MMC)	-	-	-	-	-
S1	Iron-Based, Heat-Resistant Alloys	-	500-1200	160-260	25-48	X1NiCrMoCu32 28 7, X12NiCrSi36 16, X5NiCrAlTi31 20, X40CoCrNi20 20
S2	Cobalt-Based, Heat-Resistant Alloys	-	1000-1450	250-450	25-48	Haynes® 188, Stellite® 6,21,31
S3	Nickel-Based, Heat-Resistant Alloys	-	600-1700	160-450	<48	INCONEL® 690, INCONEL 625, Hastelloy®, NIMONIC® 75
S4	Titanium and Titanium Alloys	-	900-1600	300-400	33-48	Ti1, TiAl5Sn2, TiAl6V4, TiAl4Mo4Sn2
H1	Hardened Materials	-	-	-	44-48	GX260NiCr42, GX330NiCr42, GX300CrNiSi952, GX300CrMo153, Hardox® 400
H2	Hardened Materials	-	-	-	48-55	-
H3	Hardened Materials	-	-	-	56-60	-
H4	Hardened Materials	-	-	-	>60	-
C1	CFRP, CFRP/CFRP	-	-	-	-	-
C2	CFRP/Non-Ferrous	-	-	-	-	-
C3	CFRP/High Temp	-	-	-	-	-
C4	CFRP/Stainless Steel	-	-	-	-	-
C5	CFRP/Non-Ferrous/High-Temp	-	-	-	-	-

NOVO™

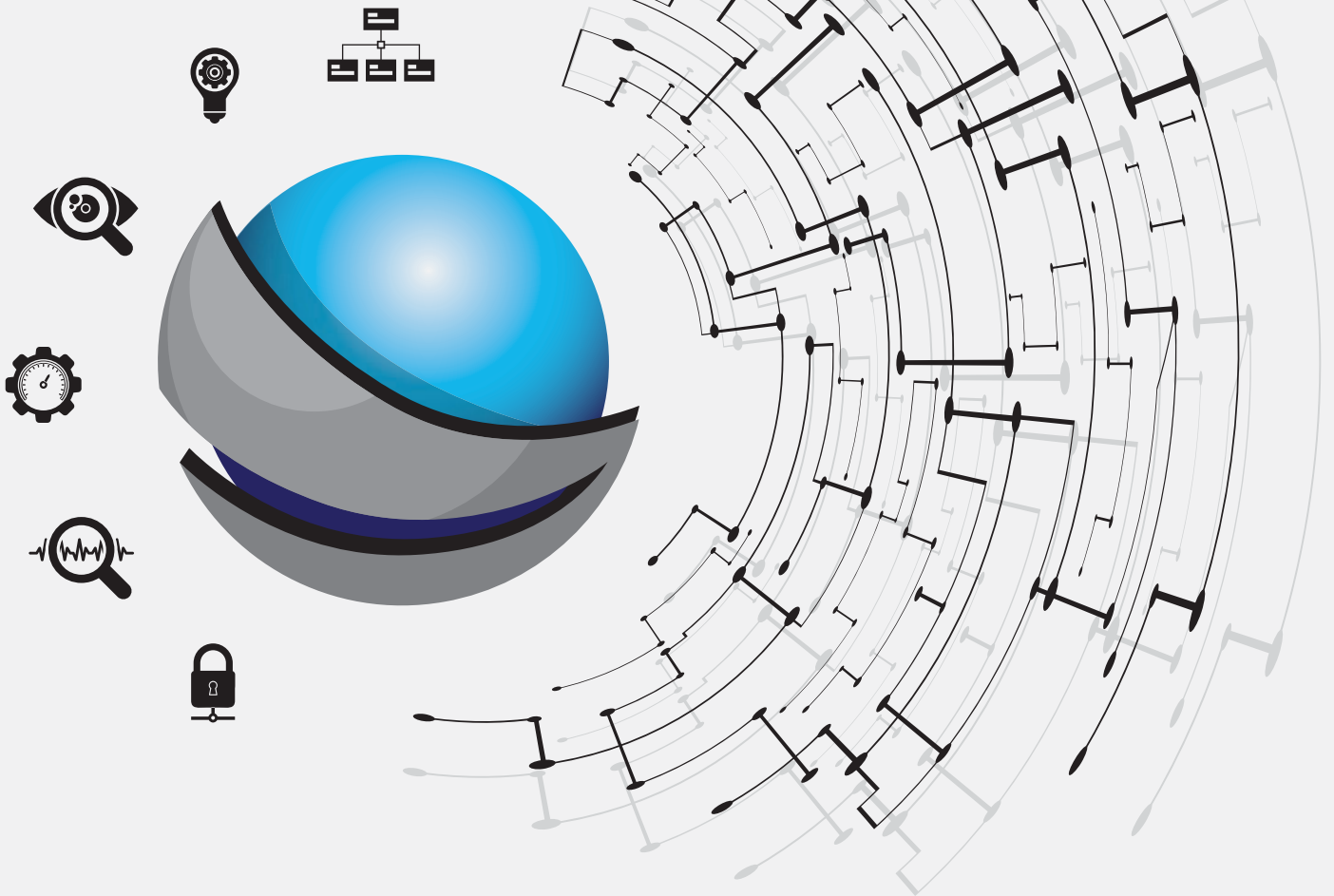

**Digitally access and leverage product data and knowledge
to connect systems and processes throughout
the entire manufacturing lifecycle.**

VISIT KENNAMETAL.COM/NOVO AND DOWNLOAD TODAY.

METALCUTTING SAFETY

IMPORTANT SAFETY INSTRUCTIONS

Read before using the tools in this catalogue!

Projectile and Fragmentation Hazards:

Modern metalcutting operations involve high spindle and cutter speeds and high temperatures and cutting forces. Hot metal chips may fly off the workpiece during metalcutting. Although cutting tools are designed and manufactured to withstand high cutting forces and temperatures, they can sometimes fragment, particularly if they are subjected to over-stress, severe impact, or other abuse.

To avoid injury:

- Always wear appropriate personal protective equipment, including safety goggles, when operating metalcutting machines or working nearby.
- Always make sure all machine guards are in place.

Breathing and Skin Contact Hazards:

Grinding carbide or other advanced cutting tool materials produces dust or mist containing metallic particles. Breathing this dust or mist — especially over an extended period — can cause temporary or permanent lung disease or make existing medical conditions worse. Contact with this dust or mist can irritate eyes, skin, and mucous membranes and may make existing skin conditions worse.

To avoid injury:

- Always wear breathing protection and safety goggles when grinding.
- Provide ventilation control and collect and properly dispose of dust, mist, or sludge from grinding.
- Avoid skin contact with dust or mist.

For more information, read the applicable Material Safety Data Sheet provided by Kennametal and consult General Industry Safety and Health Regulations, Part 1910, Title 29 of the Code of Federal Regulations.

These safety instructions are general guidelines. Many variables affect machining operations. It is impossible to cover every specific situation. The technical information included in this catalogue and recommendations on machining practices may not apply to your particular operation. For more information, consult the Kennametal Metalcutting Safety booklet, available free from Kennametal at 724 539 5747 or fax 724 539 5439. For specific product safety and environmental questions, contact our Corporate Environmental Health and Safety Office at 724 539 5066 or fax 724 539 5372.

Kennametal, the stylised K, Beyond, Beyond Evolution, ER, HARVI, HydroForce, KC643M, KCPM40, KM, KSSM, Mill 1-10, Mill 1-14, Mill 1-18, Mill 4-11, Mill 4-12^{KT}, Mill 4-15, NOVO, and Stellite are trademarks of Kennametal, Inc. and are used as such herein. The absence of a product, service name, or logo from this list does not constitute a waiver of the Kennametal trademark or other intellectual property rights concerning that name or logo.

Android™ is a trademark of Google Inc.

App Store® is a registered trademark of Apple Inc., registered in the U.S. and other countries.

Astroloy™ is a trademark of Svedala Industries, Inc. Corporation.

Daewoo™ is a trademark owned and licensed by Daewoo International Corporation.

Discoloy™ is a trademark of Westinghouse Electric Corporation.

DOOSAN™ is a trademark owned and licensed by Doosan Corporation.

Google Play™ is a trademark of Google Inc.

HAAS™ is a trademark owned and licensed by Haas Automation, Inc.

Hardox® is a registered trademark of SSAB Technology AB Corporation.

Hastelloy® and Haynes® are registered trademarks of Haynes International, Inc. Corporation.

Hostalen™ is a trademark of Hoechst GmbH Corporation.

HWACHEON™ is a trademark owned and licensed by Hwacheon Machine Tool Co., Ltd.

INCONEL®, Monel®, NIMONIC®, and Udimet® are registered trademarks of Special Metals Corporation.

INCLOY® is a registered trademark of Inco Alloys International, Inc.

INVAR® is a registered trademark of Inphy Alloys Joint Stock Company.

Lexan® is a registered trademark of Sabic Innovative Plastics IP B.V. Company.

Makrolon® is a registered trademark of Bayer Aktiengesellschaft.

Mazak® are registered trademarks of Yamamoto Kosan Kabushiki Kaisha Corporation.

OKUMA™ is a trademark owned and licensed by OKUMA Corporation.

SAFE-LOCK® is a registered trademark and Safe-Lock™ is a trademark of Haimer GmbH.

Weldon® is a registered trademark of Weldon Tool Company.

©2019 Kennametal Inc. All rights reserved.



INNOVATIONS

WORLD HEADQUARTERS

Kennametal Inc.

600 Grant Street | Suite 5100
Pittsburgh, PA 15219 USA
Tel: 1 800 446 7738
ftmill.service@kennametal.com

EUROPEAN HEADQUARTERS

Kennametal Europe GmbH

Rheingoldstrasse 50
CH 8212 Neuhausen am Rheinfall
Switzerland
Tel: +41 52 6750 100
neuhausen.info@kennametal.com

ASIA-PACIFIC HEADQUARTERS

Kennametal Singapore Pte. Ltd.

3A International Business Park
Unit #01-02/03/05, ICON@IBP
Singapore 609935
Tel: +65 6265 9222
k-sg.sales@kennametal.com

INDIA HEADQUARTERS

Kennametal India Limited

CIN: L27109KA1964PLC001546
8/9th Mile, Tumkur Road
Bangalore - 560 073
Tel: +91 080 22198444 or +91 080 43281444
bangalore.information@kennametal.com



kennametal.com